

RESIDENTIAL BUILDING SURVEY

Ealing



Copy

Marketing by:
www.1stAssociated.co.uk
0800 298 5424

CONTENTS

INTRODUCTION
REPORT FORMAT
SYNOPSIS
EXECUTIVE SUMMARY
SUMMARY UPON REFLECTION

EXTERNAL

CHIMNEY STACKS, PARAPET WALLS, DORMER WINDOWS
ROOF COVERINGS AND UNDERLAYERS
ROOF STRUCTURE AND LOFT SPACE
GUTTERS AND DOWNPIPES AND SOIL AND VENT PIPES
EXTERNAL WALLS
FASCIAS AND SOFFITS AND WINDOWS AND DOORS
EXTERNAL DECORATIONS

INTERNAL

CEILINGS, WALLS, PARTITIONS AND FINISHES
CHIMNEY BREASTS, FLUES AND FIREPLACES
FLOORS
DAMPNESS
INTERNAL JOINERY
TIMBER DEFECTS
INTERNAL DECORATIONS
THERMAL EFFICIENCY
OTHER MATTERS

SERVICES

ELECTRICITY
GAS
PLUMBING AND HEATING
BATHROOMS
MAIN DRAINS

OUTSIDE AREAS

PARKING
EXTERNAL AREAS

POINTS FOR LEGAL ADVISOR

APPENDICES

ELECTRICAL REGULATIONS
GENERAL INFORMATION ON THE PROPERTY MARKET
LIMITATIONS

———— Marketing by: ————

www.1stAssociated.co.uk

0800 298 5424

INTRODUCTION

Firstly, may we thank you for your instructions; we have now undertaken a Building Survey (formerly known as a Structural Survey) of the aforementioned property.

The Building Survey takes the following format; there is an introductory section (which you are currently reading), which includes a synopsis of the building, and a summary of our findings.

We then go through a detailed examination of the property starting with the external areas working from the top of the property down, followed by the internal areas and the buildings services. We conclude with the section for your Legal Advisor and also attach some general information on the property market.

We are aware that a report of this size is somewhat daunting and almost off-putting to the reader because of this. We would stress that the purchase of a property is usually one of the largest financial outlays made (particularly when you consider the interest you pay as well).

We recommend that you set aside time to read the report in full, consider the comments, make notes of any areas which you wish to discuss further and phone us.

We obviously expect you to read the entire report but we would suggest that you initially look at the summary, which refers to various sections in the report, which we recommend you read first so that you get a general feel for the way the report is written.

As part of our service we are more than happy to talk through the survey as many times as you wish until you are completely happy to make a decision. Ultimately, the decision to purchase the property is yours but we will do our best to offer advice to make the decision as easy as possible.

———— Marketing by: ————
www.1stAssociated.co.uk
0800 298 5424

REPORT FORMAT

To help you understand our Report we utilise various techniques and different styles and types of text, these are as follows:

GENERAL/HISTORICAL INFORMATION

This has been given in the survey where it is considered it will aid understanding of the issues, or be of interest. This is shown in "italics" for clarity.

TECHNICAL TERMS DEFINED

Throughout the Report, we have endeavoured to define any technical terms used. This is shown in "Courier New" typeface for clarity.

A PICTURE IS WORTH A THOUSAND WORDS



We utilise photographs and sketches to illustrate issues or features. In some photographs a pencil has been used to highlight a specific area. The sketches are not 100% technically accurate; we certainly would not expect you to carry out work based upon the sketches alone.

ORIENTATION

Any reference to left or right is taken from the front of the property, including observations to the rear, which you may not be able to physically see from the front of the property.

ACTION REQUIRED AND RECOMMENDATIONS

We have used the term **ACTION REQUIRED** where we believe that there are items that you should carry out action upon or negotiate upon prior to purchasing the property.

Where a problem is identified, we will do our best to offer a solution. However, with most building issues, there are usually many ways to resolve them dependent upon cost, time available and the length of time you wish the repair/replacement to last.

SYNOPSIS

SITUATION AND DESCRIPTION

This is a two storey detached period property that has had an extension into the roof. It has been amended and altered over the years. There is a small garden at the front which has been given over to parking and a garden to the rear with a patio area.

We believe that the original property was built in the Victorian era. If the age of the property interests you your Legal Advisor may be able to find out more information from the Deeds.

Putting Life into Perspective!

Some of the things that were happening around the time the property was built:

1837	Victoria becomes Queen of Great Britain.
1840	The First Postage Stamp
1851	First World Exhibition held in London
1854	Florence Nightingale pioneers modern nursing in the Crimea
1859	Charles Darwin proposes the Theory of Evolution
1868	Last public hanging in Britain
1870	British Red Cross Established
1880	Commencement of 1st Test Cricket England v Australia at the oval.
1884	Colchester earthquake four die in the UK's most destructive earthquake.
1890	The longest bridge in Britain, the Forth Bridge is opened
1899-1902	Boer War between Britain and Boers in Southern Africa
1901	Queen Victoria Died
1903	First flight by Wright Brothers
1903-1928	The Campaign for Women's Suffrage

———— Marketing by: ————

www.1stAssociated.co.uk

0800 298 5424

EXTERNAL PHOTOGRAPHS



**Victorian Detached
Property with loft
conversion**

Front view



Rear view



**Victorian Detached
Property with loft
conversion**

Left hand view



Right hand view



Front driveway



Rear garden

Marketing by: _____

www.1stAssociated.co.uk

0800 298 5424

ACCOMMODATION AND FACILITIES

Ground Floor

The ground floor accommodation consists of:

- 1) Entrance hall
- 2) Reception room on the right hand side
- 3) Kitchen/breakfast room running the length of the property
- 4) Through lounge/dining room to the left hand side
- 5) W.C.

First Floor

The first floor accommodation consists of:

- 1) Front left hand bedroom with en suite bathroom
- 2) Front right hand bedroom with en suite shower room
- 3) Rear left hand bedroom
- 4) Rear room on the right hand side (extension)

Top Floor

The top floor accommodation consists of:

- 1) Bedroom
- 2) Shower room

Outside Areas

There is a small garden at the front which has been given over to parking and a garden to the rear with a patio area.

Finally, all these details need to be checked and confirmed by your Legal Advisor.

———— Marketing by: ————

www.1stAssociated.co.uk

0800 298 5424

INTERNAL PHOTOGRAPHS

The following photos are of the internal of the property to help you recall what it looked like and the general ambience (or lack of). We have not necessarily taken photographs of each and every room.

Ground Floor



Reception room on the right hand side



Kitchen/breakfast room



Through lounge/dining room



Downstairs w.c.



Stairway

Marketing by: _____

www.1stAssociated.co.uk

0800 298 5424

First Floor

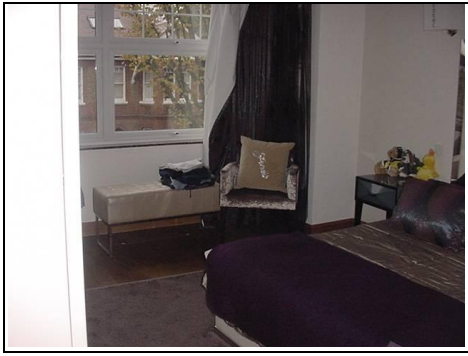

Front left hand bedroom



En-suite bathroom to front left hand bedroom



Front right hand bedroom



En-suite shower room to front right hand bedroom



Landing on first floor

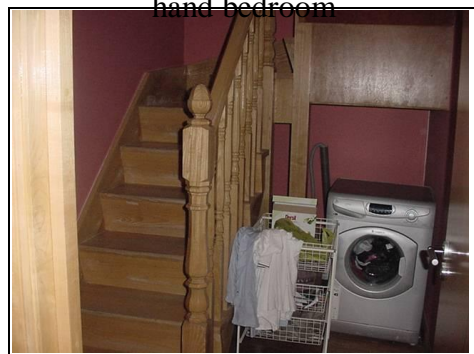

Stairs to top floor



Rear left hand bedroom



Rear room on right hand side

Marketing by: _____

www.1stAssociated.co.uk

0800 298 5424

Top Floor



Bedroom



Bathroom

Copyright: 1stAssociated.co.uk

Marketing by: _____

www.1stAssociated.co.uk

0800 298 5424

SUMMARY OF CONSTRUCTION

External

Chimneys:	Not visible
Main Roof:	Pitched, hipped roof clad with small concrete tile with roof lights added Rear felt flat roof and a rear flat roof finished with decking
Main Roof Structure:	Cut timber roof with amendments
Gutters and Downpipes:	Originally cast iron, mainly plastic
Soil and Vent Pipe:	Cast iron and Plastic
Walls:	Stretcher Bond Brickwork to the front Flemish bond and Flemish garden wall Bond brickwork to the sides Painted render to the rear
Fascias and Soffits:	Painted timber
Windows and Doors:	Double glazed windows with and without trickle vents

Internal

Ceilings:	Lath and plaster/plasterboard (assumed)
Walls:	Predominantly solid with some studwork (assumed)
Floors: Ground Floor:	Suspended timber floor (assumed)
First/Top Floor:	Joist and floorboards with embedded timbers (assumed)

Services

We are advised that the property has a mains water supply, mains drainage, electricity and gas (assumed). There is a wall mounted Vaillant boiler and there are two Megaflo cylinders located in the service cupboard. There are two electric fuse boards, one is located in a cupboard next to the entrance door and one on the first floor.

The above terms are explained in full in the main body of the Report.

We have used the term 'assumed' as we have not opened up the structure.

EXECUTIVE SUMMARY

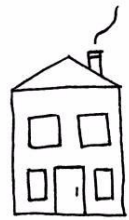

Summaries are not ideal as they try to précis often quite complex subjects into a few paragraphs. This is particularly so in a summary about someone's future home when we are trying to second-guess what their priorities are, so it is important the Report is read in full.

It is inevitable with a report on a building of this nature that some of the issues we have focussed in on you may dismiss as irrelevant and some of the areas that we have decided are part of the 'character' of this property you may think are very important. We have taken in the region of 250 photographs during the course of this survey and many pages of notes, so if an issue has not been discussed that you are interested in or concerned about, please phone and talk to us before you purchase the property (or indeed commit to purchasing the property), as we will more than likely have noted it and be able to comment upon it; if we have not we will happily go back.

We have divided the Executive Summary into 'The Good', 'The Bad' and 'The Ugly', to help distinguish what in our mind are the main issues.

The Good

Survey reports often are full of only the faults and general 'doom and gloom', so we thought we would start with some positive comments on the property!

- 1.0) Older properties typically have more space than newer properties, both in the actual size of the rooms and the height of the rooms.
- 2.0) The property has off road parking.
- 3.0) The finish of the interior uses high quality materials, albeit that these are superficial.

We are sure you can think of other things to add to this list.

The Bad

Problems / issues raised in the 'bad' section are usually solvable, but often need negotiation upon. However, a large number of them may sometimes put us off the property.

1.0) Porch

You specifically asked us to comment on the porch. We have reviewed a letter from Ealing Council dated 2/7/2010, and we have reviewed the drawing forwarded to us.

We would first of all start by saying that retrospective Planning Permission or retrospective Building Regulation permission is always hard to obtain as the Local Authority will actively discourage such practices to ensure that the Planning and Building Regulations system is upheld.

Planning Permission Defined

This relates to the aesthetics of how a building looks and how it fits in with the environment.

Building Regulations Defined

This looks at the way the building is built ensuring that good practice occurs, setting out a minimum standard of building and also Health and Safety.

In this case, as stated we have seen the 'Notice of Planning Decision' letter which granted the right subject to three conditions which are onerous.

- i) Is fairly usual saying that it should all be carried out within three years of the date of this permission.
- ii) That the development should match the appearance of the existing building. Assuming this is considered to be the front of the building as a whole, then this currently does match, however we fear that it may not be considered to be this and may be considered to be the brickwork at the side of the building which is a traditional London yellow stock brick.

Your legal advisor therefore needs to write and clarify this matter with the council whether it harmonises with the red brick to the front elevation or the yellow brick to the side elevation. Note: the reason given behind this is to meet the requirements of the Mount Park Conservation Area Policy 4.1 and 48.

iii) This relates to steps which are required to be in a matching brick to blend in. Again, the question is does the brick need to match to the porch and front elevation or the side elevations?

ACTION REQUIRED: All of the above needs to be confirmed in writing before you commit to purchasing the property.

2.0) Planning permission and Building Regulations

Bearing in mind the problems that are occurring with the porch with regards to planning permission, we would request copies of Planning Permission and Building Regulations with regard to the loft conversion and the rear extension together with confirmation that these have been completed satisfactorily to the Local Authorities approval. This should be a routine matter for your solicitor/legal advisor, you do need to check and confirm this has happened.

3.0) Roof detailing

3.1) Parapet wall

The flashing to the rear left hand parapet wall is poor and rather than stepping with the joint has been cut through the brickwork. There are also render repairs required.



Poorly fitted flashing to the rear left hand parapet wall

ACTION REQUIRED: Check lead flashing and carry out render repairs to the parapet walls. This may need scaffolding.

ANTICIPATED COST: In the region of £2,000 - £5,000. We would budget for £10,000 as we suspect there will be other high level areas of work that we cannot physically see from the ground level. Please obtain quotations.

Please see the Roof Coverings Section of this Report.

4.0) Flat roofs

To the rear of the property are two flat roofs. The flat roof that we can see is felt and unfortunately it is flat rather than having a fall on it. This means that:

- i) There is a risk of water getting in below although we couldn't visually see any at the time of our inspection and
- ii) That the roof will deteriorate quicker than is typically expected, which in our experience has a life of fifteen to twenty five years.



Flat roof to rear of property

You can see that there is weathering already on part of the mineral felt roof covering.

The second roof to the rear is covered with a wood decking meaning that we can't actually see the roof, however we can see that there is no flashing between the roof and the main building.



Wood decking covering the roof. Here we can see where the decking meets the main wall where there is no flashing

ACTION REQUIRED: With the felt roof you need to expect there to be an above average number of repairs sooner rather than later. With the wood decking covered roof, we recommend removing the wood decking to expose the roof to check the condition of it. We expect it could go one of two ways, either a perfect example of roofing with the exception of the flashing or a roof in poor condition.

ANTICIPATED COST: In a worst case scenario, we would expect costs to be in the region of £10,000 - £20,000 to re-roof the property. In a best case scenario, the cost will literally be just for removing the decking to check the area and adding a flashing which would be in the region of a few thousand pounds.
ew thousand pounds. Please obtain quotations.

Please see the Roof Coverings Section of this Report.

Copyright: 1stAssociated.co.uk

———— Marketing by: ————
www.1stAssociated.co.uk
0800 298 5424

5.0) Cracking and movement

We can see throughout the rear of the property there is cracking to the render particularly on the left hand side at high level. We can also see that repairs have been carried out to cracking indicating that it is a known about problem. The cracking could be for many reasons, from movement to the cement being too hard at the rear of the property; however we feel that you need to specifically ask the current owners if any underpinning or structural work has taken place to the property.



Crack in the render to the rear



Crack at high level



Close up of crack at high level

Cracks that have been repaired which are now hairline



Cracking to the rear left hand side



Low level cracking to the rear left hand side

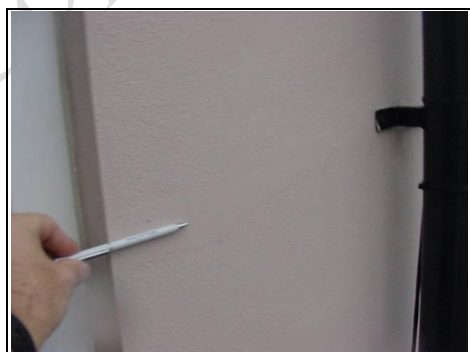

Covered up cracking



Cracking to the render

ACTION REQUIRED: To be on the safe side, we would recommend the present owners put in an insurance claim identifying this cracking was noted during the course of a building survey, but as it was a one-off inspection it couldn't be conclusive. The insurance company will then carry out monitoring over a period, usually a year (as recommended by the Building Research Establishment) and carry out work as necessary. This all needs to be in writing as this would then limit your cost to the excess within the insurance and any supplements they would then charge you if and when work was carried out.

ANTICIPATED COST: We would expect at least double the excess to be taken off the purchase price for taking on this risk. Please obtain quotations.

Please see the Walls Section of this Report.

Copyright: 1stAssociated.co.uk

———— Marketing by: ————
www.1stAssociated.co.uk
0800 298 5424

6.0) Dampness

We have found rising damp on the right hand side of the property and we believe we would also find it to the rear if the walls weren't hidden by the kitchen units. This we believe is due to the high ground level.



Low level rising damp

ACTION REQUIRED: We would recommend in the first instance the lowering of the ground level around the right hand side and rear of the property. Unfortunately this would be quite a lot of work as the whole area has been paved which is part of the problem as they have been added over the existing ground level rather than lowering it. This has then allowed the dampness in.



Right hand side is too high and needs the ground level lowering

6.1) Damp companies selling injection damp proof coursing

We can see to the left hand side and also to some of the right hand side, that there have been numerous previous attempts at inserting a damp proof course. We believe the problem to be on the right hand side and rear due to the high ground level and on the left hand side we believe is due to the render bridging the damp proof course, this requires a bell mouth to the render.



Damp proof course has been inserted on the left hand side



Damp proofing on right hand side

ACTION REQUIRED: It is important that both these works are done correctly as unless this happens, the dampness will remain.

ANTICIPATED COST: In the region of £10,000 - £20,000; quotations required.

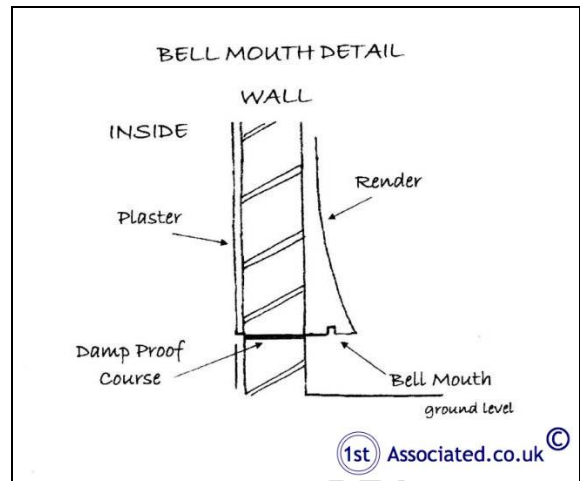

Please see the Damp Proof Course and Dampness Sections of this Report.

7.0) Poor ventilation to the suspended timber floor

There is a suspended timber floor that you can't see because it has been clad with a ceramic tile throughout the interior of the property. However we do know this type of construction and suspect that there could be a timber floor beneath it that is deteriorating due to the lack of airflow. There would normally be vents however we haven't managed to find them in this instance with the exception of those in the photos below. The airflow underneath the building is needed to ensure the chances of wet rot, dry rot and woodworm are reduced.

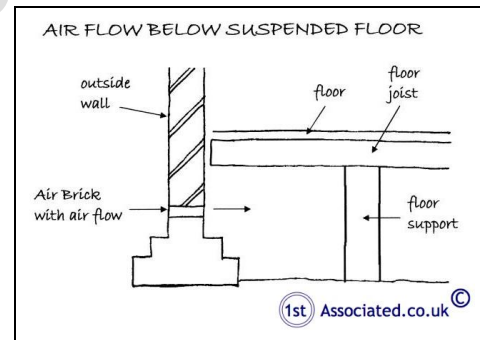

ACTION REQUIRED: You need to ensure that all the current air vents are clear and allow a flow of air. You need to open up a section of the floor to check the condition of the timber underneath. If there is any dampness or deterioration then we would recommend additional airbricks are added to the rear.

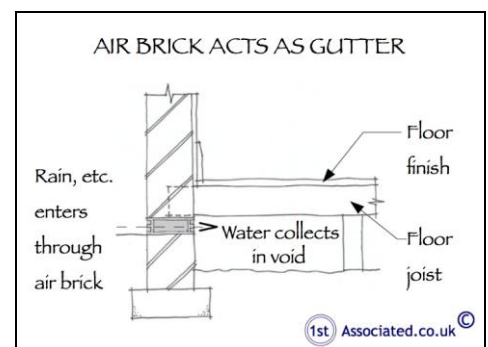

We suspect that additional airbricks were originally to the rear but these have been covered up by the decorative paving slabs that have been added.



Airbricks acting as a gutter to the rear



Airbrick acting as a gutter on the right hand side

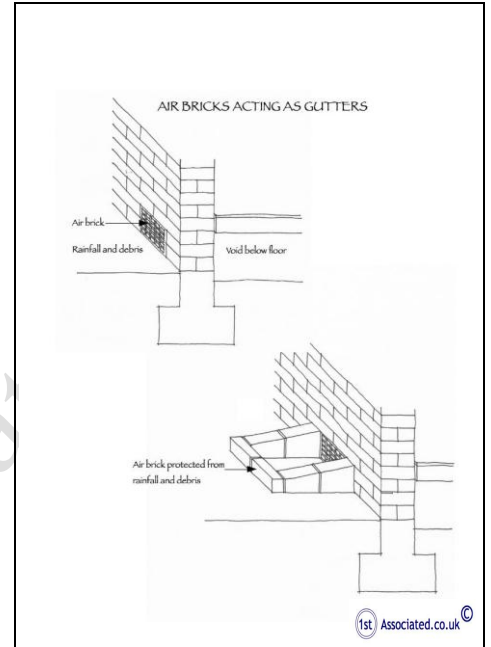

ANTICIPATED COST: A worst case scenario would be £10,000 plus, a best case scenario would be in the region of £1,000 - £5,000; please obtain quotations.

Please see the Floors and Airbricks Sections of this Report.

Copyright: 1stAssociated.co.uk

Marketing by: www.1stAssociated.co.uk
0800 298 5424

8.0) Tiles on wood

Throughout the property there are ceramic tiles onto wooden suspended timber floors. This mix of solid material in the form of the tiles onto a timber which deflects and moves with the seasons does get differential movement, which requires re-grouting. Over the years, the only way we have found around this is to have an expansion joint and sit on top of the tile coving which we don't see in this instance. If this isn't put into the original design, then it is very difficult to add it afterwards. Unfortunately we couldn't see it in this instance.

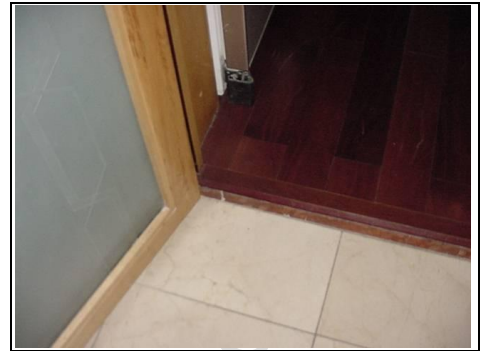

Tiles to wooden floor with a step on the ground floor

ACTION REQUIRED: We feel you just have to accept that repointing of the joints will be needed from time to time.

ANTICIPATED COST: A few hundred pounds as this work becomes necessary; please obtain quotations.

Please see the Floors Section of this Report.

9.0) Condensation possible

The property has several en suite bathrooms where we couldn't see proper ventilation.

ACTION REQUIRED: We would recommend that you ask the current owner to show you the ventilation working properly. If not present already, add humidity controlled extract fans.

Please see the Dampness Section of this Report.

10.0) Deterioration to showers

We could see some deterioration to some of the showers. This can often occur where the shower isn't bedded down properly and a hollow shower is used rather than a solid shower.

ACTION REQUIRED: Each shower to be checked for deterioration and re-mastic.

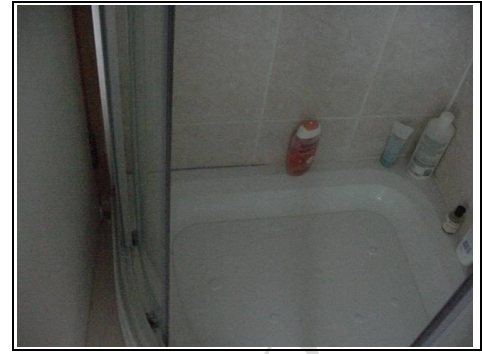

Deterioration to shower

ANTICIPATED COST: A minimum of a few hundred pounds. To replace could be thousands of pounds depending upon how easily it can be replaced; please obtain quotations.

Please see the Bathrooms Section of this Report.

11.0) Services

11.1) Heating the property

We noted in some areas there was under floor heating. Generally we do not find this to be a very economic way of heating a property although it can be argued that heating from the ground through a tile is generally considered to be the most comfortable way of heating a property.

Please see the Plumbing and Heating Section of this Report.

The Ugly

We normally put here things that we feel will be difficult to resolve and will need serious consideration.

There is nothing which we feel falls within this section providing you are happy with the characteristics of the property which we have mentioned throughout the report and are happy to do the measures identified.

Other Items

Moving on to more general information.

Maintenance

It should be appreciated that defects which would normally be highlighted in a modern property, effectively form part of an older property's overall character and style. Such defects are considered acceptable and may not have been specifically referred to as defects within the context of this Report.

This type of property will require ongoing maintenance and repair and a budget for such work must be allowed to ensure it is maintained in good condition. This will prevent undue and unnecessary deterioration.

Services

Whilst we have carried out a visual inspection of the services within the property we also need to advise you of the following:

Electrics

For the electrics we would recommend an Institute of Electrical Engineers standards (IEE) test and report carried out by an NICEIC registered and approved electrical contractor or equivalent, which is recommended whenever a property changes occupancy.

Heating

We would recommend that the system be tested and overhauled before exchange of contracts and that a regular maintenance contract be placed with an approved heating engineer.

Drainage

Whilst we have lifted the manhole covers the only true way to find out the condition of the drains is to have a closed circuit TV camera report to establish the condition of the drains. In this age of property there have often been leaks over the years.

Water Supply

There is danger in older properties of having a lead water supply; we would recommend that you speak to the water company to ask them if they have carried out such replacement, as you will be re-piping much of the water used in the building it gives an ideal opportunity to also check for any remaining lead pipes.

ACTION REQUIRED: We would reiterate that we recommend with regard to all services that you have an independent check by a specialist contractor.

DIY/Handyman Type Work

There are numerous other items that we would class as DIY or handyman type work such as redecorating to turn the property into your home. We have detailed these and other issues within the main body of the report.

Purchase Price

We have not been asked to comment upon the purchase price in this instance, we have however referred you to sources of general information on the housing market within the Information on the Property Market Section, which can be found in the Appendices at the end of the Report.

Every Business Transaction has a Risk

Every business transaction has a risk, only you can assess whether that risk is acceptable to you and your circumstances. You should now read the main body of the Report paying particular attention to any “**ACTION REQUIRED**” points.

Estimates of Costs

Where we have offered an estimate of building costs please remember we are not experts in this area. We always recommend you obtain quotations for the large jobs before purchasing the property (preferably three quotes). The cost of building work has many variables such as the cost of labour and estimates can of course vary from area to area when giving a general indication of costs. For unskilled labour we currently use between £75 and £100 per day (the higher costs in the city areas) and for tradesmen we use between £100 and

£200 per day for an accredited, qualified, skilled tradesman. Other variations include the quality of materials used and how the work is carried out, for example off ladders or from scaffold.

If you obtain builders estimates that vary widely, we would advise the work is probably difficult or open to various interpretations and we would recommend a specification is prepared. It would usually be best to have work supervised if it is complex, both of which we can do if so required.

Copyright: 1stAssociated.co.uk

SUMMARY UPON REFLECTION



The Summary Upon Reflection is a second summary so to speak, which is carried out when we are doing the second or third draft a few days after the initial survey when we have had time to reflect upon our thoughts on the property. We would add the following in this instance:

Further investigation does have to take place prior to committing to purchase this property. You do need to get specific agreements with regard to the planning issue to the porch and also with regard to the movement to the rear of the property. We would refer you to our comments in the Executive Summary, 'Good', 'Bad' and 'Ugly' Section and ask that you re-read these.

As a general comment for any work required we would always recommend that you obtain at least three quotations for any work from a qualified, time served tradesperson or a competent registered building contractor prior to legal completion.

We would ask that you read the Report in full and contact us on any issues that you require further clarification on.

Copyright: 1stAssociated.co.uk

———— Marketing by: ————
www.1stAssociated.co.uk
0800 298 5424

MORE ABOUT THE REPORT FORMAT

Just a few more comments about the Report format before you read the actual main body of the Report.

TENURE – FREEHOLD (OR AS GOOD AS)

We have assumed that the property is to be sold Freehold or Long leasehold, with no unusual or onerous clauses and that vacant possession will be available on completion. Your Legal Advisor should confirm that this is the case.

ESTATE AGENTS – FRIEND OR FOE?

It is important to remember that the estate agents are acting for the seller (usually known as the vendor) and not the purchaser and are therefore eager to sell the property (no sale – no fee!). We as your employed Independent Chartered Surveyor represent your interests only.

SOLICITOR/LEGAL ADVISOR

To carry out your legal work you can use a solicitor or a legal advisor. We have used both terms within the report.

TERMS OF ENGAGEMENT/LIMITATIONS

This report is being carried out under our terms of engagement for Building Surveys, as agreed to and signed by yourselves. If you have not seen or are not happy with the terms of engagement please phone immediately 0800 298 5424 or email the secretary from which this survey came from.

OUR AIM IS ONE HUNDRED PERCENT SATISFACTION

Our aim is for you to be completely happy with the service we provide, and we will try and help you in whatever way possible with your property purchase - just phone us.

THE DETAILED PART OF THE REPORT FOLLOWS, WORKING FROM THE TOP OF THE PROPERTY DOWNWARDS

We believe the property falls within a Conservation Area based upon the information you have provided (your Legal Advisor should confirm this and make their own enquiries).

As such, as you have discovered it will require various permissions to be obtained before work is carried out, over and above that normally required and possibly the use of appropriate materials for the age, type and style of property which may be more costly.



Marketing by: _____
www.1stAssociated.co.uk
0800 298 5424

EXTERNAL

CHIMNEY STACKS

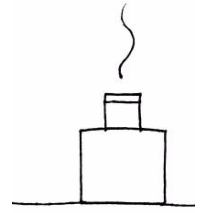

Chimney Stacks

Chimneys developed originally from open fires placed within buildings. From this, the chimney has developed to its present day format where it is used as an aesthetic feature and focal point rather than purely just to heat the room.

We were surprised not to find any chimneys visible to the property externally on either the front or rear elevation. However we do suspect that these have been removed over the years. Where chimneys have been removed a Planning Permission and Building Regulations application is usually required.

ACTION REQUIRED: Your legal advisor to check and confirm if there has been Planning and Building Regulations applications and approval for chimney removals. This may have formed part of the work when adding the loft conversion.

Chimneys on adjoining properties

As these properties were all built at the same time, they are likely to have originally had the same chimneys. We can see on the adjoining properties that there were chimneys both to the left hand and to the right hand side.

ACTION REQUIRED: It is important that you ensure that these chimneys have been removed correctly or what remains in place is structurally sound.

The inspection was made from ground level within the boundaries of the property (unless otherwise stated) using a x16 zoom lens on a digital camera. A closer inspection may reveal latent defects.

Please also see Chimney Breasts, Flues and Fireplaces Section of this Report.

ROOF COVERINGS AND UNDERLAYERS

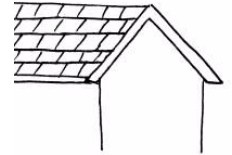

The Roof Coverings and Underlayers section considers the condition of the outer covering of the roof. Such coverings usually endure the extremes of climate and temperatures. They are susceptible to deterioration, which ultimately leads to water penetration.

Dependent upon the age of your property and the type of construction it may or may not be present, please read on:

We will consider the roofs in three areas, the main roof, the porch roof and the flat roofs to the rear.

Main Roof

The main roof is hipped, pitched and clad with small concrete tiles and, from ground level, this looks in average condition considering the roofs age type and style. With this age of roof there will usually be a few missing or displaced tiles, this is nothing unusual. In this instance we could see some displaced tiles to the front gable end. These looked like they had been lifted by the wind and need replacing.



Tiles slightly displaced to the front

ACTION REQUIRED: A roofer to replace displaced tiles. Carry out periodic inspections and maintenance of the roof, as required.

ANTICIPATED COST: A few hundred pounds; quotations required.



Close up of roof tiles

Marketing by: _____

www.1stAssociated.co.uk
0800 298 5424

Parapet Walls

Parapet walls are usually walls that are above roof level and often sit on the boundary of the property.

In this case there is a parapet wall to the left hand side. It is a brick built parapet wall that has been rendered and is in below average condition. Please see our comments in the Executive Summary.



Poorly fitted flashing to the rear left hand parapet wall

Render Defined

A sand and cement external coating applied in two or three coats or layers.

Finally, we were only able to see approximately ten percent of the parapet wall, therefore we have made our best assumptions based upon what we could see. A closer inspection may reveal more.

Dormer Windows

Dormer windows are often used where rooms are formed within the roof space and have the advantage of allowing light into the area and also giving the head space to allow them to be stood next to.

To the rear of the property a dormer window has been added as part of the loft conversion. There is a flat felt roof which we were unable to see, the cheeks of the dormer are clad in tiles and the windows are plastic double glazed. Generally we could comment for its age, type and style it is in average condition.



Dormer window

Finally, Dormer windows have been viewed from ground level and literally from the dormer windows themselves.

Roof Windows

(Known as roof lights or Velux windows which is the trade or generic name)

Three roof windows have been added to the front and one to the side as part of the loft conversion. These are a modern manufactured roof light and looked in reasonable condition. The important factor with roof lights is the flashing around them, in this instance we could see it looked in average condition although there was some moss sitting around it.



Roof windows

It seems inevitable with roof windows that they will sooner or later leak. If this doesn't occur then they seem prone to condensation. Keep a cloth handy!



Copyright: 1stAssociated.co.uk

Protective Underlayer (Often known as the sarking felt or underfelt)

From the 1940s onwards felts were used underneath tiles/slates to stop wind damage and water penetration, these in more recent years have been replaced with plastic equivalents. These are commonly known as underfelts but now the name is not really appropriate, as felt is not the only material used.

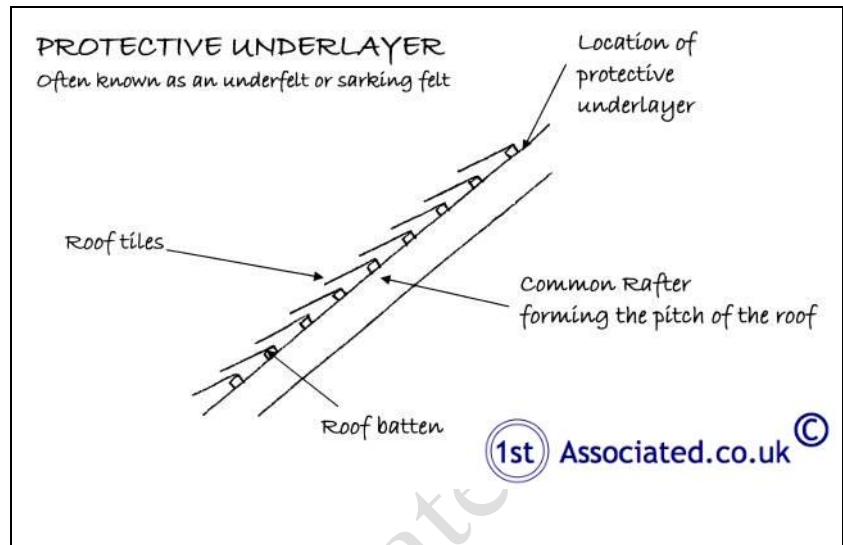

We were only able to see a very small area of the protective underlayer. This we found to be a Hessian base Bitumen membrane. We could only see approximately five percent of the underside of the roof. The Hessian based membrane has been used since the 1960s. We generally found the little we could see to be in average condition.



This photo shows the common rafters (the ones that form the pitch of the roof) and the dark area between is the protective underlayer

Marketing by: www.1stAssociated.co.uk
0800 298 5424

Porch roof

There is a shallow pitched roof over the porch that we assume has been put at that pitch to miss the decorative band of brickwork running across the property. We can see that the flashing has been added poorly. Rather than stepping the brickwork which is traditional with this age of property, it has been cut into the brickwork.



Flat Roofs

Whilst these roofs are called "flat", present building regulations and good building practice presently requires a minimum fall of 12 degrees.

Flat roofs are formed in a variety of materials. Difficulties can arise when the water is not discharged from the roof but sits upon it, as this can soon lead to deterioration which flat roofs are renowned for.

There are three flat roofs, one over the dormer windows that we have already mentioned and the two rear flat roofs. Please see our comments in the Executive Summary with regards to these.

We have added information with regards to Building Regulations as some work here seems to have been carried out with disregard to Building Regulations. The latest Building Regulations require flat roofs to be ventilated. Building Regulations are not retrospective but the reason for the requirement is to make sure that any moisture that enters the roof construction is dispelled by way of ventilation. We would suggest that if the opportunity arises ventilation should be provided. This will stop the possibility of fungal growth above the ceiling in the flat roof area.

Also it could not be established if there is insulation within the roof or a vapour barrier, without the vapour barrier and combined with inadequate ventilation there will be an increase in the risk of wet or dry rot.

All the roofs were inspected from ground level with the aid of a x16 zoom lens on a digital camera. Flat roofs have been inspected from upper floor windows and ground level and the roofs themselves.

Finally, we were only able to see approximately sixty percent of the main roof from ground level via our ladder or via any other vantage point that we managed to gain. We have made our best conclusions based upon what we could see; however a closer inspection may reveal other defects.

For further comments with regard to ventilation please see the Roof Structure and Loft Section.

Copyright: 1stAssociated.co.uk

ROOF STRUCTURE AND LOFT

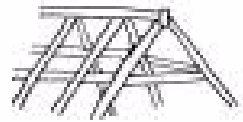

(ALSO KNOWN AS ROOF SPACE OR ATTIC SPACE)

The roof structure or framework must be built in a manner which is able to give adequate strength to carry its own weight together with that of the roof covering discussed in the previous section and any superimposed loads such as snow, wind, foot traffic etc.

Main Roof

Roof Access

The main roof is accessed via a cupboard door on the rear right hand side of the top floor loft conversion. There are other cupboards in the sides of the loft conversion area but these were lined so we couldn't see the roof.

Roof Structure

We could literally see five to ten percent of the roof structure. We would take an educated guess that this was originally a hand cut roof similar to the one in the adjoining sketch, however this has been amended and altered to allow the space for the loft conversion.

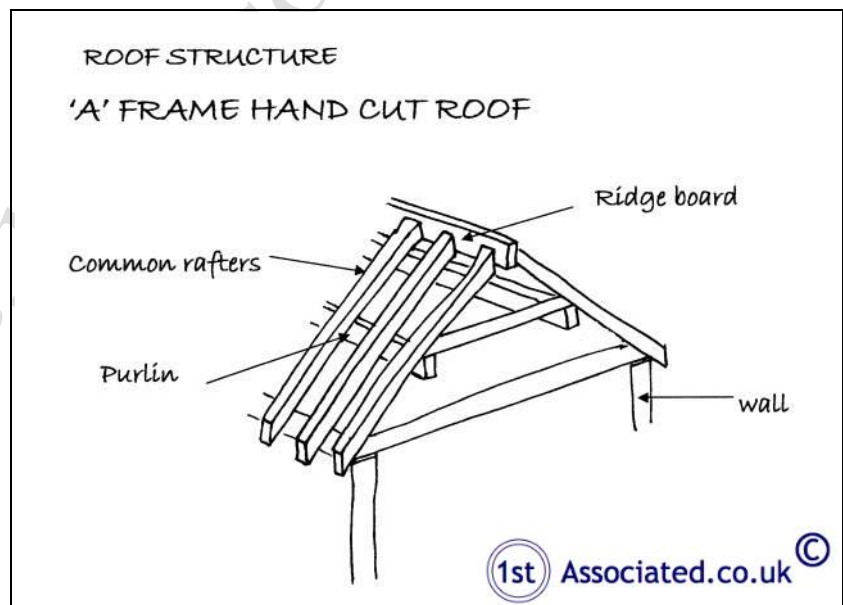

Roof Timbers

We have inspected the roof structure for:

- Serious active woodworm
- Structurally significant defects to the timbers
- Structurally significant dry rot
- Structurally significant wet rot

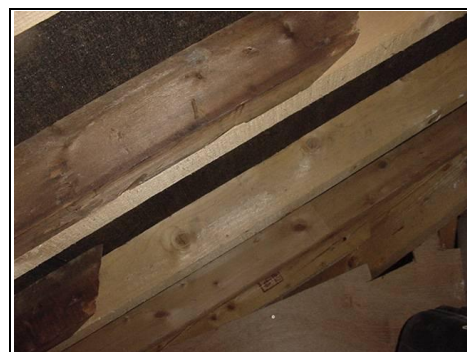

Roof viewed in rear right hand cupboard space on the top floor

Our examination was very limited due to the loft conversion. The timbers we could see were newer timbers and were thinner and smaller in profile than we expected but without seeing the whole roof we cannot be certain of how it is constructed. It may, for example, have a metal frame within it which would allow the size of the timbers to be reduced.

ACTION REQUIRED: You need to obtain plans of the loft conversion for us to comment further on.

Ventilation

We could see no ventilation which is what we would expect in a Building Regulation approved loft conversion.

Insulation

It is unknown within the roof. Please see the Thermal Efficiency Section of this Report.

Electrical Cables

We can often identify the age of an electrical installation by the age of wiring found in the roof. In this case there was insufficient quantity of wiring to comment. Please see our further comments in the Services Section of this Report.

Finally, we would ask you to note that this is a general inspection of the roof, i.e. we have not examined every single piece of timber. We have offered a general overview of the condition and structural integrity of the area.

Copyright: 1stAssociated.co.uk

———— Marketing by: ————
www.1stAssociated.co.uk
0800 298 5424

GUTTERS AND DOWNPIPES



The function of the gutters and downpipes is to carry rainwater from the roof to the ground keeping the main structure as dry as possible.

Defective gutters and downpipes are a common cause of dampness that can, in turn, lead to the development of rot in timbers. Regular inspection and adequate maintenance are therefore essential if serious problems are to be avoided.

Gutters and Downpipes

From ground level the gutters and downpipes are plastic and are in average condition. There may be some minor leaks, but we feel that most people could live with these. Carry out repairs within the next six to twelve months.

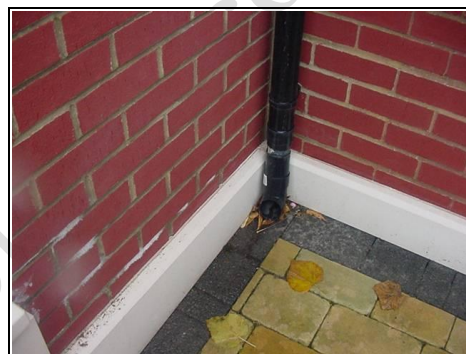

Plastic downpipe discharging onto the ground

ACTION REQUIRED: We would recommend you stand outside the property next time it rains heavily and see how well the drains cope with the rainwater particularly looking at the guttering and the joints. We would always recommend that the gutters and downpipes are cleaned out, the joints are checked and the alignment checked to ensure that the gutters fall towards the downpipes.

Soil and Vent Pipe

The property originally had cast iron soil and vent pipes, part of the cast iron can be seen in the adjoining photo to the base of the property. The remainder is in plastic.

Cast iron of this age can crack and rust and needs regular maintenance.



Soil and vent pipe – cast iron to plastic

Finally, gutters and downpipes and soil and vent pipes have been inspected from ground level. We had light rain during the survey but not sufficient for it to be possible to confirm 100 per cent that the rainwater installation is free from blockage, leakage etc. or that it is capable of coping with long periods of heavy rainfall. Our comments have therefore been based on our best assumptions.



Soil and vent pipe

Copyright: 1stAssociated.co.uk

Marketing by: www.1stAssociated.co.uk
0800 298 5424

WALLS

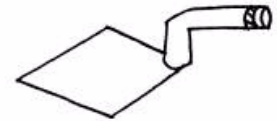

External walls need to perform a variety of functions. These include supporting upper floors and the roof structure, resisting dampness, providing adequate thermal and sound insulation, offering resistance to fire and being aesthetically presentable.

The walls are constructed of Stretcher Bond brickwork to the front, Flemish bond and Flemish garden wall bond brickwork to the sides and painted render to the rear.

Front elevation

To the front elevation there is Stretcher Bond brickwork which isn't what is typically found in this age of property, we more commonly come across a Flemish Bond brickwork.

The whole of the front looks to be quite modern, almost as if it has been stuck on. Although there were examples of stretcher bond in Victorian times they are relatively rare and have problems with the wall ties rusting.

Cavity walls were first used in Victorian times. It originates from solid walls not always being waterproof against driving rain and not providing a good degree of heat insulation. The design of cavity walls makes them relatively unstable and they depend upon the wall ties.

Walls of cavity construction should incorporate ties to hold together the inner and outer leaves of masonry. As there is no access to the cavity it has not been inspected and we cannot comment on the presence or condition of wall ties.

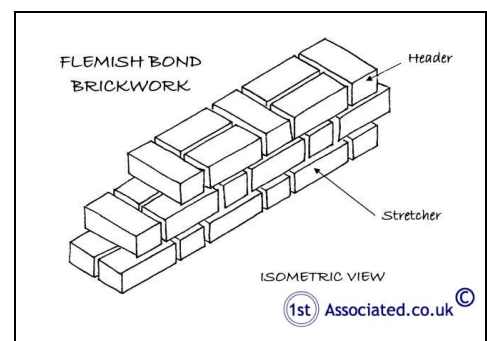
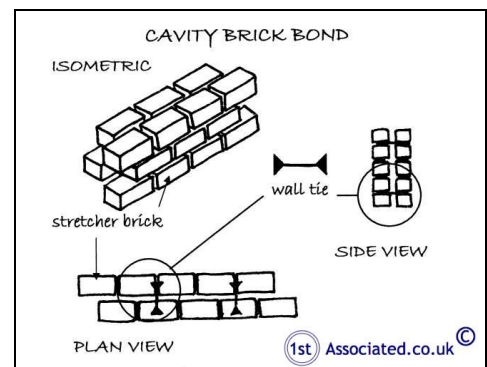

Side walls

The side walls are in a Flemish Bond, some of them are in a Flemish garden wall bond.



Flemish Bond

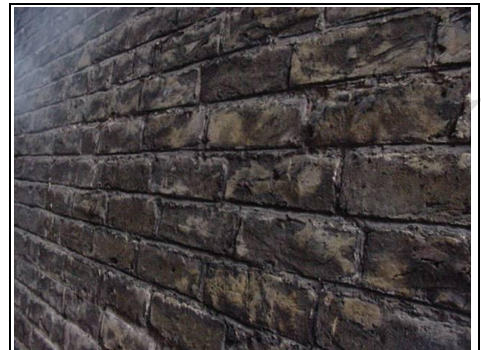

Flemish garden wall bond

Render to the rear

The external walls to the rear are finished in a smooth faced painted render. We are always wary when we see rendered properties as it usually means they have been rendered for a particular reason.

In this particular case we believe it has been added at a later date as we cannot see it on adjoining properties. It looks a new style cement render.



Render to the rear

Marketing by: _____

www.1stAssociated.co.uk

0800 298 5424

Render Detailing

You can normally tell whether the render is good or not by the drip detail over the window and the bell mouth to the base of the property.

Bell mouth window drip detail

In this case we could see window drip details.

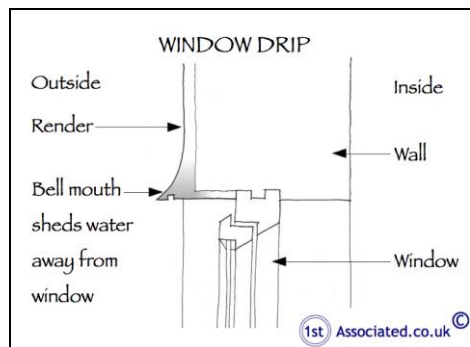

Drip details over the window on the render to the rear

Bell mouth to the base

However to the base where we would expect to find a drip detail, there is no detail.

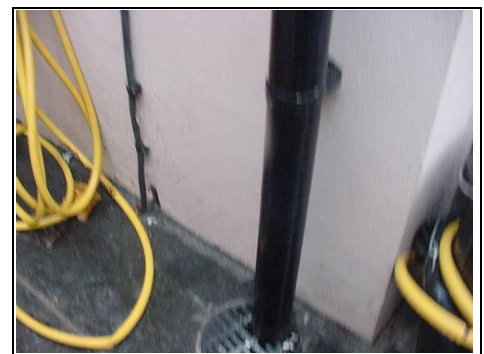
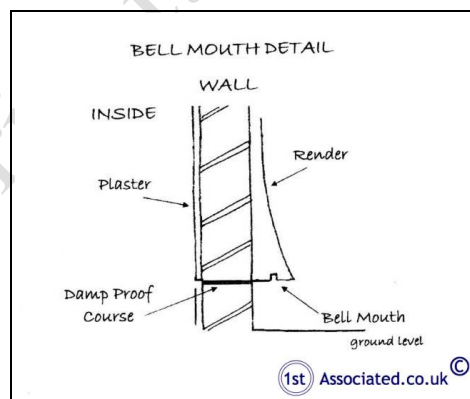

No bell mouth

ACTION REQUIRED: Please see our comments within the Executive Summary with regards to adding a bell mouth.

Cracking

Please see our comments within the Executive Summary.

We would remind you that any hairline cracks that appear, which tends to be the case with render, need to be sealed as soon as possible to stop dampness and water getting in and causing blisters and hollow areas.

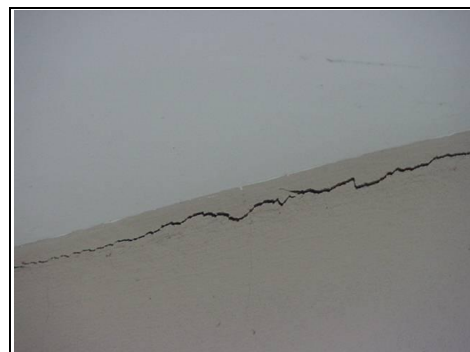

Close up of crack at high level



Old cracks that have been repaired previously

Painted render/painted walls

Do not underestimate the amount of time/cost it will take to repaint the property particularly as there is high level work which is likely to need scaffolding which can be expensive.

Finally, the external walls have been inspected visually from ground level and/or randomly via a ladder. Where the window and door lintels are concealed by brickwork / painted render / plasterwork we cannot comment on their construction or condition. In buildings of this age timber lintels, concrete lintels, rubbed brick lintels, or metal lintels are common, which can be susceptible to deterioration that is unseen, particularly if in contact with dampness.

Our comments have been based upon how the brickwork / painted render / plasterwork has been finished. We have made various assumptions based upon what we could see and how we think the brickwork / painted render / plasterwork would be if it were opened up for this age, style and type of construction. We are however aware that all is not always as it seems in the building industry and often short cuts are taken. Without opening up the structure we have no way of establishing this.

FOUNDATIONS



The foundations function is, if suitably designed and constructed, to transfer the weight of the property through the soil. As a general comment, many properties prior to the 19th Century have little or no foundations, as we think of them today, and typically a two-storey property would have one metre deep foundations.

Foundations

Given the age of the property you may find different depths of foundations. We would expect to find a stepped brick foundation to the original property with possibly a concrete foundation for the more recent extension work, for example to the rear.

London Clay

As with most properties in the London area, this property stands on London Clay. It is therefore more susceptible than most should drains leak or trees be allowed to overgrow etc. It is not unusual to have some settlement in London properties.

Building Insurance Policy

You should ensure that the Building Insurance Policy contains adequate provision against any possibility of damage arising through subsidence, landslip, heave etc.

It is your responsibility to check out prior to commitment to purchase that insurance is available on the property on the basis of the things we have reported in the survey. Much as we would like to we are unable to keep up with the changing insurance market and give you advice with regard to this. Please remember to talk about any cracks identified within the property. Often insurers will refer to progressive and non-progressive cracking. Unfortunately this is something we are unable to comment upon from a one-off inspection - the Building Research Establishment recommend a year of monitoring of any cracking.

We would always recommend that you remain with the existing insurance company of the property.

We would refer you to our comments with regard to building insurance throughout this report.

Finally, we have not excavated the foundations but we have drawn conclusions from our inspection and our general knowledge of this type, age and style of property.

As no excavation has been carried out we cannot be 100 percent certain as to how the foundation has been constructed and we can only offer our best assumptions and an educated guess, which we have duly done.

Copyright: 1stAssociated.co.uk

———— Marketing by: ————
www.1stAssociated.co.uk
0800 298 5424

TREES

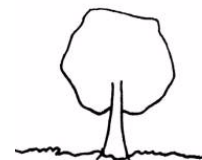

Trees within influencing distance of a property can affect the foundations by affecting the moisture content of the soil.

There is a tree within what we would term as influencing distance of the property. You need to keep it well maintained; it is likely to add to your insurance premium as it is so close to the house. It could be argued that this is causing the problem with regard to the cracking to the rear of the property which is why it is important to ensure that you have an insurance claim in place and agreed before you commit to purchasing the property.

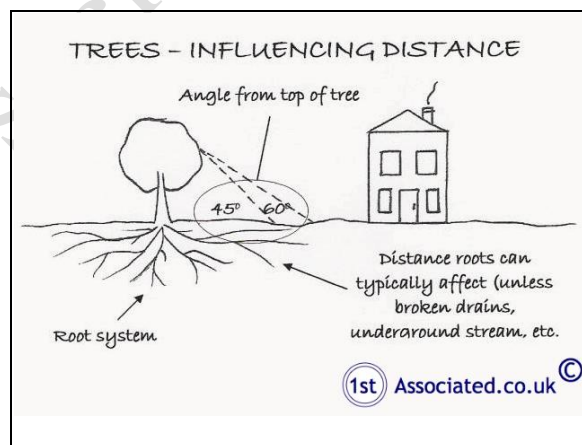
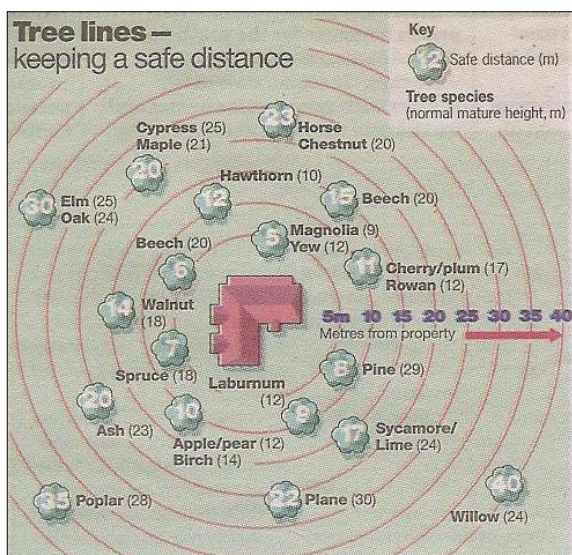
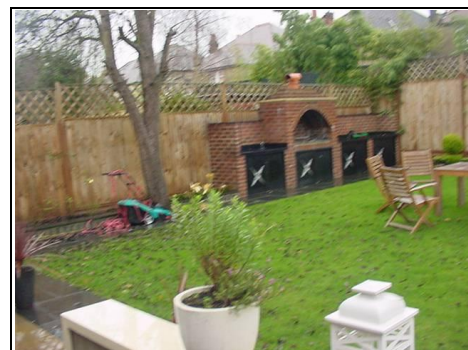

Influencing Distance Defined

This is the distance in which a tree may be able to cause damage to the subject property. It is not quite as simple as our sketch; it depends on the tree, its maturity, the soil type etc., etc.

Finally, insurance requirements with regard to trees have varied over the years and in our opinion have got ever more onerous. We have seen the notifiable distance of a tree away from a property to have been reduced over the years and we reiterate our comments elsewhere within this report that you need to make enquiries with regard to the insurability of your property in relation to trees and other features when you purchase the property.

Please also refer to the External Areas Section.



DAMP PROOF COURSE

The Building Act of 1878 required a damp proof course to be added to all newly built properties within the London area. It also required various other basic standards. These requirements were gradually taken up (or should that be grudgingly taken up) throughout London and then the country as a whole, although this took many years for it to become standard practice.

All modern properties should incorporate a damp proof course (DPC) and good building practice dictates that a differential of 150mm (6 inches) should be maintained between the damp proof course and ground levels. In this case, we can see that numerous damp proof courses have been inserted.

ACTION REQUIRED: Please see our comments in the Executive Summary.

Your attention is drawn to the section of the report specifically dealing with dampness.

Finally, sometimes it is difficult for us to identify if there is a damp proof course in a property. We have made our best assumptions based upon our general knowledge of the age, type and style of this property.



Damp proof course has been inserted on the left hand side



Damp proofing on right hand side

AIRBRICKS

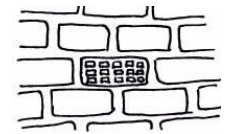

In properties with suspended floors you need to have an airflow beneath to stop deterioration. The air is allowed to pass under the property by the use of airbricks. Generally the rule of thumb is that airbricks are spaced every metre and a half approximately, but this depends upon the specific circumstances of the property.

Low Level Air Bricks

Air bricks are essential to have a through flow of air as this helps to reduce the chances of wet rot, dry rot and woodworm.

ACTION REQUIRED: Please see our comments within the Executive Summary.

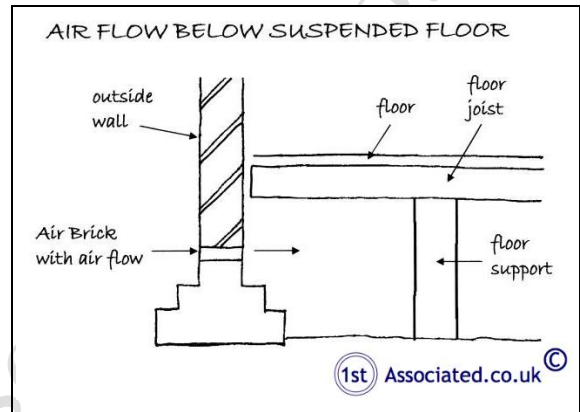

Left hand airbrick



Airbrick acting as a gutter



Airbrick acting as a gutter on the right hand side

Finally, we have made our best assumptions based upon our visual inspection of the outside of the property and our general knowledge of this age, type and style of construction. We have not opened up the floor, unless we have specifically stated so in this section.

FASCIAS AND SOFFITS AND WINDOWS AND DOORS

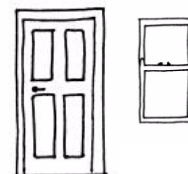

This section covers fascias, soffits and bargeboards and windows and doors, and any detailing such as brick corbelling etc.

Fascias and soffits offer protection to the rafter feet and also allow the securing of the guttering. Windows primary functions are to admit light and air, but they also have thermal and sound properties. The doors allow access and egress within the property.

Fascias and Soffits

The fascias and soffits are timber. They are painted and we would comment they are in average condition for their age, type and style.

ACTION REQUIRED: Make sure gutters and downpipes are watertight before carrying out any work on fascias and soffits.



Fascias and soffits

Windows and Doors

The property has plastic double glazed windows, which generally look to be of an average quality. Some of the windows have trickle vents and some do not.

We would draw your attention to the fact that sealed double glazed units can fail, particularly as a result of poor workmanship during installation. Failure of the seal leads to condensation between the two panes of glass and simply replacing the affected units may not provide a satisfactory long-term solution. In this case they are in average condition.



Trickle vents defined

Trickle vents allow a trickle of air through, therefore stopping/reducing the likelihood of condensation occurring within the property.

Enquiries should be made as to the existence of any transferable guarantees. Generally it is considered that double glazed units have a life of about ten years.

Finally, we have carried out a general and random inspection of the external joinery. In the case of the fascias and soffits it is typically a visual inspection from ground level. With the windows and doors we have usually opened a random selection of these during the course of the survey. In this section we are aiming to give a general overview of the condition of the external joinery. Please also see the Internal Joinery section.

Copyright: 1stAssociated.co.uk



EXTERNAL DECORATIONS

The external decorations act as a protective coat for the building from the elements. Where this protective covering has failed, such as with flaking paintwork, the elements will infiltrate the structure. This is of particular concern as water is one of the major factors in damage to any structure.

The render redecoration and the fascias and soffits are in reasonable condition at present. However you do need to seal the hairline cracking that has been noted to the render as soon as possible to stop the chances of blisters occurring in the render.

Finally, ideally external redecoration is recommended every four to five years dependent upon the original age of the paint, its exposure to the elements and the materials properties. Where painting takes place outside this maintenance cycle repairs should be expected. Ideally redecoration should be carried out during the better weather between mid-April and mid-September.

Please see our comments in the External Joinery section.

Copyright: 1stAssociated.co.uk

Marketing by: www.1stAssociated.co.uk
0800 298 5424

INTERNAL



CEILINGS, WALLS, PARTITIONS AND FINISHES

In this section we look at the finish applied to the structural elements such as the plasterwork applied to the ceiling joists, walls or partitions, together with the construction of the internal walls and partitions.

Ceilings

From our visual inspection of the ceilings and our general knowledge of this age and type of construction we believe that the ceilings are a mixture originally of lath and plaster and more modern areas in plasterboard. These are what we would call decorative feature ceilings which in our opinion add an overall good impression to the property.



Ceiling detail

Lath and Plaster Defined

Laths are thin strips of timbers which are fixed to the structure. Wet plaster is applied to the laths, usually in several layers. The plaster forms a key as it is forced between the laths. This plaster, once dry, is given further coats and often a decorative finish.

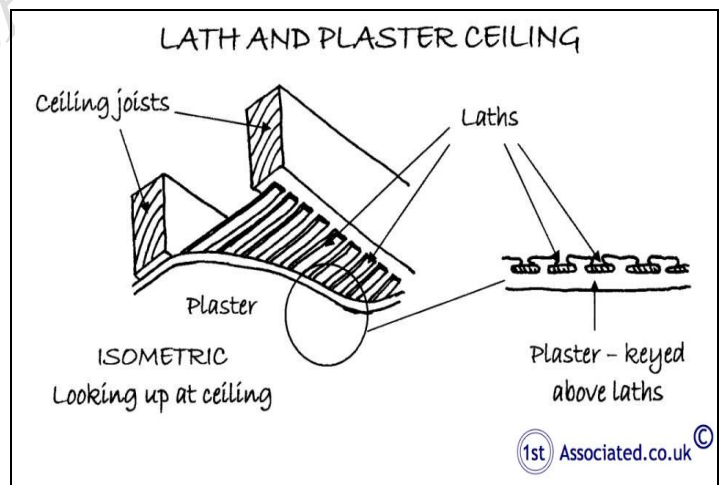

Plasterboard Defined

The usual name for Gypsum plasterboard which is building board with a core of aerated gypsum, usually enclosed between two sheets of heavy paper, used as a dry lining.

Internal Walls and Partitions

These are, we believe predominantly solid with some studwork construction. It is of course impossible to determine the construction without opening up the walls and we have therefore taken an educated guess. We noticed some differential movement cracking which we would put down to all the various alterations that have taken place in the property.



Hairline cracking on the stairway on top floor

Perimeter Walls

Originally these would have been finished with a wet plaster however they are very smooth and look like they have had a skim coat with modern gypsum plaster.

Again, we cannot be 100% certain of the wall construction without opening them up which goes beyond the scope of this report. This comment has been based on the look of the wall which is relatively “smooth”.

Finally, ceilings, walls and partitions have been inspected from floor level and no opening up has been undertaken (unless permission has been obtained by yourselves). In some cases the materials employed cannot be ascertained without samples being taken and damage being caused.

We cannot comment upon the condition of the structure hidden behind plaster, dry lining, other applied finishes, heavy furniture, fittings and kitchen units with fitted back panels.

CHIMNEY BREASTS, FLUES AND FIREPLACES

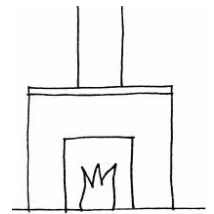

With the advent of central heating fireplaces tend to be more a feature than an essential function in most properties.

The chimney breast that we can see is in the front right hand reception room which makes it in the centre of the property, however when viewed at roof level there is no longer a chimney there.

ACTION REQUIRED: Please see our comments with regards to chimneys and checking with the Local Authority that there has been approval to remove the chimneys.

Finally, we will comment on the condition of the chimney breast where we can see the chimney breast. If we can see a chimney breast has been removed we will inspect for signs of movement and advise. However, often the chimney breasts are hidden and we do not comment as modern techniques for adding support can concealed very well particularly when plastered over.

Your Legal Advisor needs to specifically check with the Local Authority for removed chimneys and associated chimney breasts and Building Regulations Approvals and advise by e-mail immediately if chimney breasts are found to have been removed. We would recommend opening up the structure to check the condition. If we are not advised we will assume the relevant Building Regulations Approval has been obtained.

It is strongly recommended that flues be cleaned and checked for obstructions prior to use to minimise the risk of hazardous fumes entering the building.

Please also see the Chimney Stacks Section of this report.

FLOORS



Functionally floors should be capable of withstanding appropriate loading, preventing dampness, have thermal properties and durability. In addition to this upper floors should offer support for ceilings, resistance to fire and resistance to sound transfer.

Ground Floor

The floors to the property are suspended timber floors which are covered with ceramic tiles and wood flooring which has limited our inspection.

ACTION REQUIRED: Please see our comments within the Executive Summary with regards to the problems that can occur where ceramic tiles are laid over timber floors.

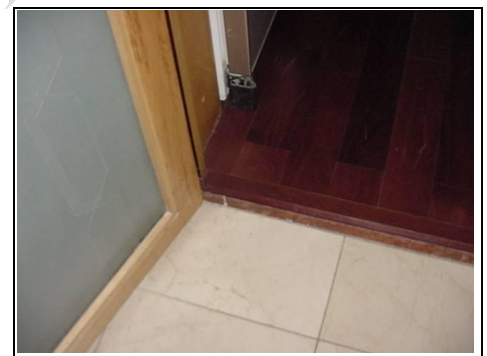
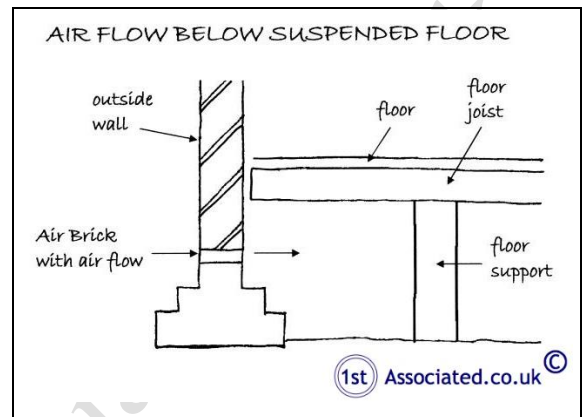

Tiles to wooden floor with a step on the ground floor

First Floor

We have assumed that the first floor construction is joist and floorboards with embedded timbers, as this is typical in this age of property.

ACTION REQUIRED: Again the first floor is also covered with tiles and wooden flooring. Please see our comments within the Executive Summary.

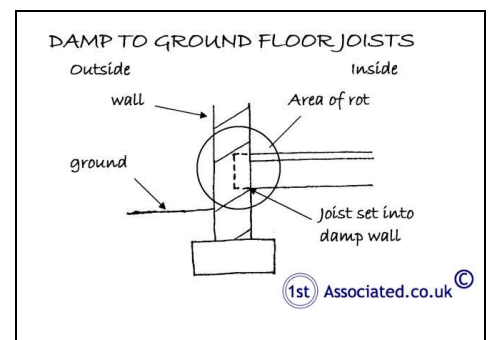

Joist and Floorboard Construction Defined

These are usually at first floor level consisting of a joist supported from the external walls, either built in or, in more modern times, sitting upon joist hangers, sometimes taking additional support from internal walls, with floorboards fixed down upon it.

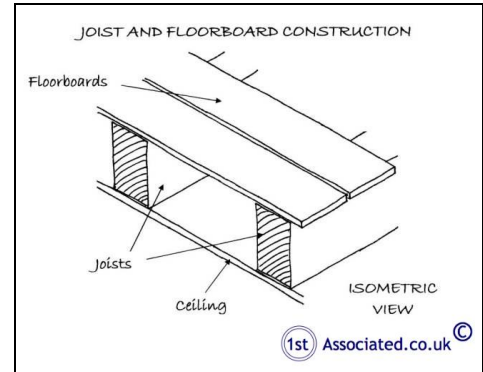

Top Floor

We have assumed that the first floor construction is joist and floorboard sheets; this is also covered with wooden flooring.

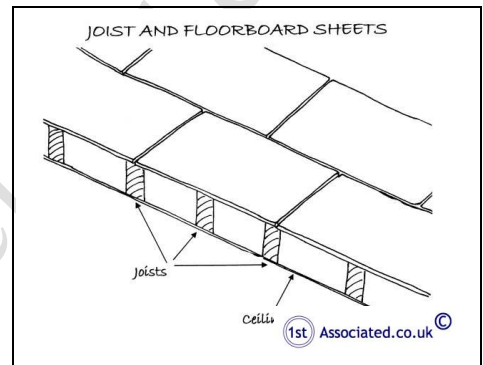

Finally, we have not been able to view the actual floors themselves due to them being covered with tiles, wood flooring etc. The comments we have made are based upon our experience and knowledge of this type of construction. We would emphasise that we have not opened up the floors in any way or lifted any floorboards.



DAMPNESS

In this section we look at any problems that are being caused by dampness. It is therefore essential to diagnose the source of the dampness and to treat the actual cause and not the effect of the dampness.

Rising Damp

Rising damp depends upon various components including the porosity of the structure, the supply of water and the rate of evaporation of the material, amongst other things. Rising damp can come from the ground, drawn by capillary action, to varying degrees of intensity and height into the materials above.

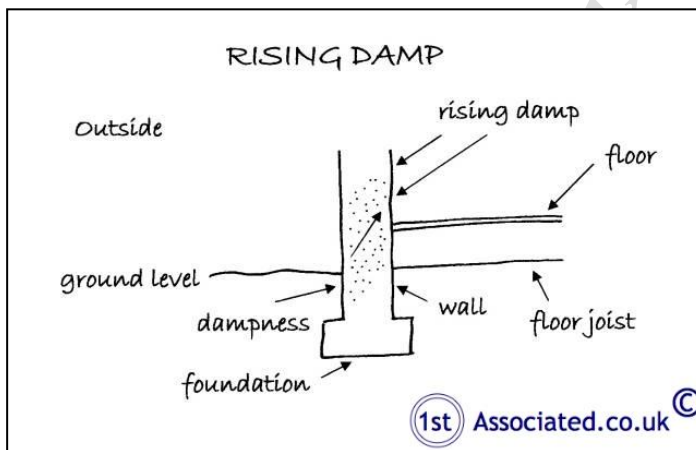

A random visual inspection and tests with a moisture meter have been taken to the perimeter walls. In this particular case we have found rising damp to the right hand side of the property.

ACTION REQUIRED: Please see the Executive Summary.

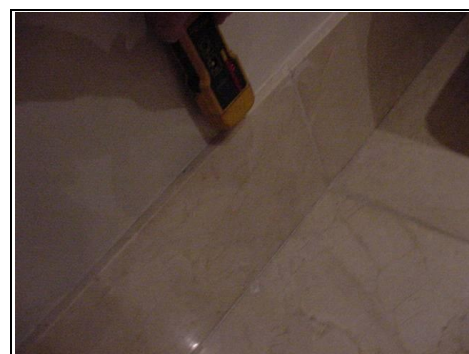

Rising damp

Lateral or Penetrating Dampness

This is where water ingress occurs through the walls. This can be for various reasons such as poor pointing or wall materials or inadequate gutters and downpipes, such as poorly jointed gutters.

We used a damp meter on the external walls. We have not found dampness.

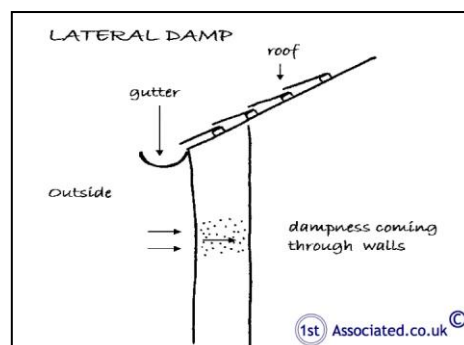

Condensation

This is where the humidity held within the air meets a cold surface causing condensation.

At the time of the inspection there were no obvious signs of condensation however the property has several en suite bathrooms where we couldn't see proper ventilation.

Condensation depends upon how you utilise the building. If you do your washing and then dry it in a room without opening a window you will, of course, get condensation. Common sense is needed and a balance between heating and ventilation of properties. Normally opening windows first thing in the morning resolves most condensation issues.

Extract fans in kitchens and bathrooms

A way of helping to reduce condensation is to have good extract fans within the kitchens and bathrooms.

ACTION REQUIRED: We would recommend humidity controlled extract fans be added to kitchens and bathrooms if they are not present.

Finally, effective testing was prevented in areas concealed by heavy furniture, fixtures such as kitchen fittings with backboards, wall tiles and wall panelling. We have not carried out tests to BRE Digest 245, but only carried out a visual inspection.

INTERNAL JOINERY

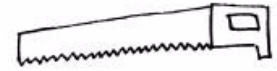

This section looks at the doors, the stairway, the skirting boards and the kitchen to give a general overview of the internal joinery's condition.

Doors

There is a variety of modern doors. Some of them are glazed, these should have a British Standards kite mark to ensure that they are safety glass; we couldn't see it in this instance.

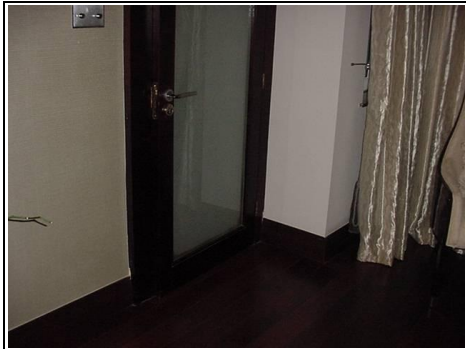

Glass doors



Internal door

Staircase

We noted that the underside of the staircase was exposed. Worse still, the services cupboard has the boiler in it. It hasn't been carried out to current Building Regulations standards as it is more normal today to have a half hour fire barrier to stop fire spreading from the ground floor to the first floor in a worse case scenario.

ACTION REQUIRED: Add a lining.

Kitchen

We found the kitchen in average condition. We have not tested any of the kitchen appliances.

Finally, it should be noted that not all joinery has been inspected. We have viewed a random sample and visually inspected these to give a general overview of the condition. Please also see the External Joinery/Detailing section.

TIMBER DEFECTS

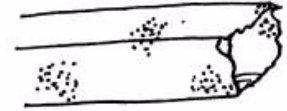

This section considers dry rot, wet rot and woodworm. Wet and Dry rot are species of fungi, both need moisture to develop and both can be very expensive to correct. We would also add that in our experience they are also often wrongly diagnosed.

Dry Rot

*Dry rot is also sometimes known by its Latin name *Serpula lacrymans*. Dry rot requires constant dampness together with a warmish atmosphere and can lead to extensive decay in timber.*

We have not visually seen any dry rot during the course of our inspection. We would advise that we have not opened up the floors and we had a very limited view of the roof (five to ten per cent).

Wet Rot

*Wet rot, also known by its Latin name *Contiophora puteana*, is far more common than dry rot. Wet rot darkens and softens the wood and is most commonly seen in window and doorframes, where it can relatively easily be remedied. Where wet rot affects the structural timbers in a property, which are those in the roof and the floor areas, it is more serious.*

Again, we have not visually seen any wet rot during the course of our inspection. We did have a very limited view of the floors and of the roof. Our concern is that there is some wet rot present in the floors due to the lack of ventilation.

Woodworm



Active woodworm can cause significant damage to timber. There are a variety of woodworm that cause different levels of damage with probably the worst of the most well known being the Death Watch Beetle. Many older properties have woodworm that is no longer active, this can often be considered as part of the overall character of the property.

The roof / floor are the main areas that we look for woodworm. We have had a limited view of the roof and unfortunately we were unable to see the actual floor structure due to the floor coverings. In this case we have viewed a very small amount of timber; we would estimate less than five percent of the entire timber in the property. We therefore feel there is a possibility of woodworm, for example in the floor area.

ACTION REQUIRED: If you wish to be 100 per cent certain that there is no woodworm you need to open up the floor for it to be checked and examined.

Any signs that are found should be treated to prevent it spreading. However, you need to be aware that many damp and woodworm treatment companies have a vested interest in selling their products and therefore have fairly cleverly worded quotations where they do not state if the woodworm they have found is 'active'. You should ask them specifically if the woodworm is active or not.

We would also comment that any work carried out should have an insurance backed guarantee to ensure that if the company does not exist, or for whatever reason, the guarantee is still valid. More importantly it is essential to ensure that any work carried out is carried out correctly.

Copyright: 1stAssociated.co.uk

———— Marketing by: ————
www.1stAssociated.co.uk
0800 298 5424

INTERNAL DECORATIONS



With paints it should be remembered that up to 1992 lead could be used within paint and prior to this most textured paints (commonly known as Artex) contained an element of asbestos up to 1984, so care should be taken if the paintwork looks old and dated.

Internal decorations are in average condition. You may wish to redecorate to your own personal taste.

Finally, we would draw your attention to the fact that removal of existing decorative finishes may cause damage to the underlying plasterwork necessitating repairs and making good prior to redecoration.

Copyright: 1stAssociated.co.uk

Marketing by: _____

www.1stAssociated.co.uk

0800 298 5424

THERMAL EFFICIENCY



Up until the mid 1940s we did not really consider insulation in properties, for example it was only in the 1960s that we started putting insulation in the roof and then it was about 50mm, in the 1970s this was upgraded to 100mm. Then we started to think about double glazing and cavity wall insulation. Since then insulation standards have increased considerably and today we are looking at typically using insulation not only in the roof but also in the walls, floors and windows and more recently considerable work has been carried out on how efficient boilers are within properties. Care has to be taken that properties are not insulated disproportionately to the ventilation as this can cause condensation and you should be aware that you need to ventilate any property that is insulated.

HIPs

We understand that HIPs were suspended from 20th May 2010. Energy Performance Certificates are required before a sale completes.

Roofs

There has been very limited access into the roof. What we could see didn't have insulation, however if this loft conversion has been carried out quite recently, then Building Regulations will require it to have insulation.

Walls

The walls to this property are solid in the sense that they do not have a cavity as a modern property would have. Also they are unlikely to have any substantial insulation, however; unfortunately it is generally very difficult to improve the insulation without affecting the external or the internal appearance of the property.

Windows

The windows are double glazed and therefore will have reasonable thermal properties.

Services

Service records should be obtained. It is essential for the services to be regularly maintained to run efficiently.

Summary

Assuming the above is correct, this property is average to below average depending upon the roof insulation. However we would additionally comment that the heating in the house via the floor, etc will be expensive to run if this property isn't well insulated.

Further information can be obtained with regard to energy saving via the Internet on the following pages:

[HTTP//www.est.org.uk](http://www.est.org.uk), which is by the Energy Saving Trust and includes a section on grant aid.

or alternatively www.cat.org.uk

or Sustainable Energy Without the Hot Air by David J C MacKay [HTTP//www.withouthotair.com/Videos.html](http://www.withouthotair.com/Videos.html) to download for free or buy a paper copy as we did.

It is worth watching the video How Many Light Bulbs? by David J C MacKay [HTTP//www.youtube.com/watch?v=UR8wRSp21Xs](http://www.youtube.com/watch?v=UR8wRSp21Xs)

Finally, we would comment that energy we feel will become a major consideration in years to come, particularly with the greater focus in modern buildings on energy efficiency.

What does my energy bill pay for?

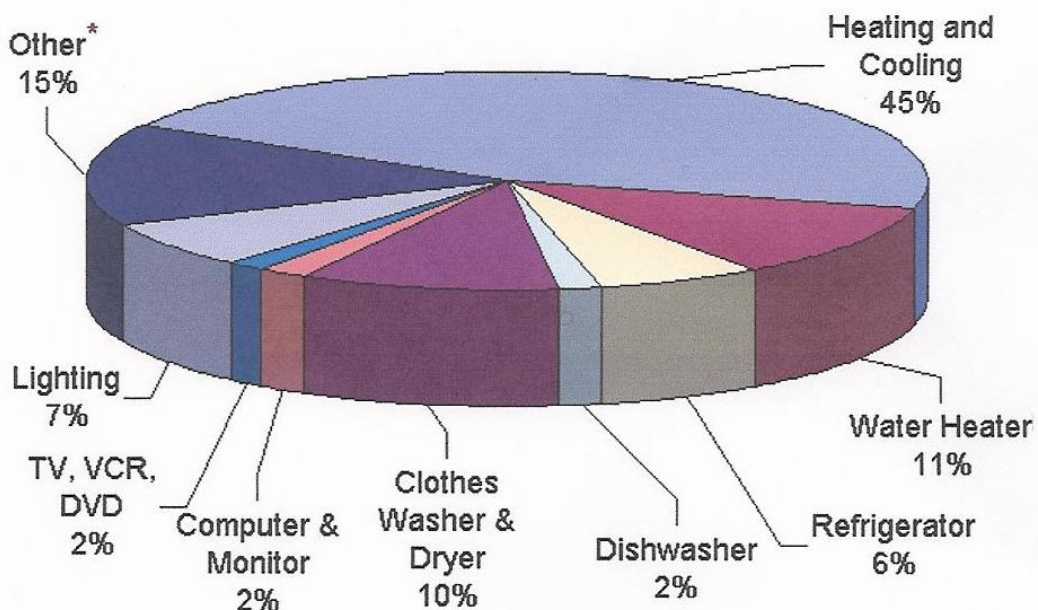

*"Other" represents an array of household products, including stoves, ovens, microwaves, and small appliances. Individually, these products account for no more than about 2% of a household's energy bills.

OTHER MATTERS



In this section we put any other matters that do not fit under our usual headings.

Security

A security system has been installed. A good alarm system should not only help reduce break-ins but also your insurance. We are not experts in this field and therefore cannot comment further.

ACTION REQUIRED: Further information should be obtained from the vendor and the installer at a later date.

Fire / Smoke Alarms

Some smoke detectors were noted. The current Building Regulations require that they be wired into the main power supply. Obviously in a property of this age this is difficult, as it would mean having surface mounted wires or cutting wiring into the plaster.

ACTION REQUIRED: We would recommend, for your own safety, that smoke detectors be installed. We would always recommend a hard wired fire alarm system and are also aware that some now work from a wireless signal which may be worth investigating. Whilst fire is relatively rare it is in a worst case scenario obviously devastating.

Insurance

We would always recommend staying with the existing insurance company, and then if there are any problems you should not have the difficulty of negotiating with two insurance companies passing the blame between each other.

We would refer you to our comments with regard to building insurance throughout this report.

———— Marketing by: ————
www.1stAssociated.co.uk
0800 298 5424

Asbestos

In a property of this age there may well be some asbestos, we didn't note any from our visual inspection. Asbestos was commonly used post war until it was banned only in the last ten or so years, although it is rumoured that it was still used after this point in time. We are not asbestos surveyors.

ACTION REQUIRED: If you wish to confirm you are 100 percent free of asbestos you need to have an asbestos survey carried out.

Copyright: 1stAssociated.co.uk

———— Marketing by: ————
www.1stAssociated.co.uk
0800 298 5424

68

SERVICES

This survey does not include any specialist reports on the electricity supply and circuits, heating or drainage, as they were not requested. The comments that follow are based upon a visual inspection carried out as part of the overall Building Survey.

Services and specialist installations have been visually inspected. It is impossible to examine every detail of these installations without partially dismantling the structure. Tests have not been applied. Conclusive tests can only be undertaken by suitably qualified contractors. The vendor/seller should be requested to provide copies of any service records, test certificates and, ideally, the names and addresses of the installing contractors.

Copyright: 1stAssociated.co.uk

———— Marketing by: ————
www.1stAssociated.co.uk
0800 298 5424

ELECTRICITY



It is strange to think that electricity only started to be used in domestic properties at the turn of the 19th century with gas lighting still being the norm for a good many years after.

Periodic inspections and testing of electrical installations is important to protect your property from damage and to ensure the safety of the occupants. Guidance published by the Institute of Electrical Engineers (IEE) recommends that inspections and testing are undertaken at least every 10 years (we recommend every five years) and on change of occupancy. All electrical installation works undertaken after 1st January 2005 should be identified by an Electrical Installation Certificate.

Fuse Boards

Quite unusually this property has two electric fuse boards. One is located in a cupboard on the ground floor next to the entrance door, the other one is at first floor level. This may have been added due to the under floor heating being electric.

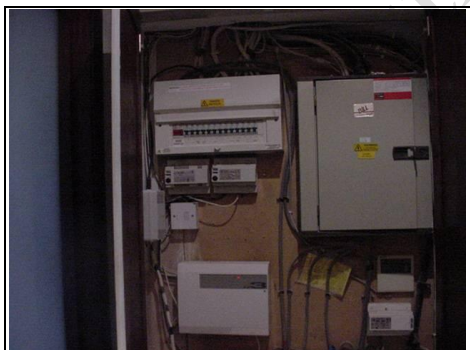

Circuit board on ground floor



Fuse Board on first floor

ACTION REQUIRED: You need to specifically ask the owner why two fuse boards are present. We would add that we were pleased to see that the fuse boards were relatively modern.

Earth Test

We carried out an earth test in the kitchen area to the socket point that is normally used for the kettle, this proved satisfactory.



Earth Test

ACTION REQUIRED: As the property is changing occupancy an Institute of Electrical Engineers (IEE) test and report should be carried out by a NICEIC registered and approved electrical contractor.

In addition to this your Legal Advisor is required to make full enquires with the owners to establish if any electrical installation work has been carried out and to provide suitable certification for any works carried out after 1st January 2005. Any comments made within this report or verbally do not change this requirement.

For basic general information on this matter please see the appendices at the end of this report.

———— Marketing by: ————
www.1stAssociated.co.uk
0800 298 5424

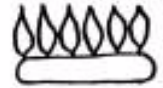

There is very little we can check for in a gas installation, we do inspect to make sure there is one and that it has a consumer unit and that the boilers are vented. Ideally you should have a service inspection carried out by an independent Gas Safe registered plumber.

We assume that the property has mains gas going to the Services Cupboard on the rear right hand side.

All gas appliances, pipework and flues should be the subject of an annual service by a competent engineer, i.e., a member of Gas Safe; works to gas appliances etc., by unqualified personnel is illegal. Unless evidence can be provided to confirm that there has been annual servicing we would recommend that you commission such a service prior to use to ensure safe and efficient operation.

ACTION REQUIRED: As a matter of course it is recommended that the entire gas installation is inspected and made good, as necessary, by a Gas Safe registered contractor. Thereafter the installation should be serviced annually.

Copyright: 1stAssociated.co.uk

PLUMBING AND HEATING



In this section we do our best from a visual inspection to look at how the water is supplied to the property, how the supply is distributed around the property, how it is used to heat the property and how it is discharged from the property.

Water Supply

The owner advised that the controlling stopcock is located outside, on the side of the building.

ACTION REQUIRED: Ask the owners to show you where it is.

Water Pressure

When the taps were run to carry out the drainage test we checked the pressure literally by putting a finger over the tap and this seemed average. The Water Board have to guarantee a certain pressure of water to ensure that things like boilers, particularly the instantaneous ones have a constant supply of pressured water (they would blow up if they didn't!).

Hot Water Cylinder

There are two modern Megaflo hot water cylinders. In our experience we have found these to be very good. This type of cylinder hasn't been in existence for that long.



Megaflo Cylinders

Pressurised cylinder

We noted that the system is pressurised which means that pressure is added to enable the water supply to reach all the parts of the building. These need regular maintenance.

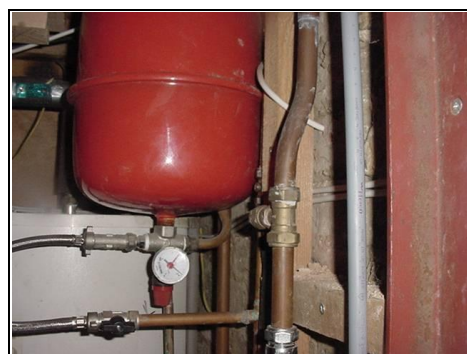

Pressurised cylinder

Heating

The boiler is a wall mounted Vaillant which is located in the Services cupboard on the rear right hand side.

Our limited inspection of the hot water and central heating system revealed no evidence to suggest any serious defects but we would nevertheless recommend that the system be tested and overhauled before exchange of contracts and that a regular maintenance contract be placed with an approved heating engineer.

Ten Minute Heating Test

The heating was on during the course of the survey, the property was warm.



We removed one of the radiator covers

Air cooling units

These are located on the right hand side of the property. We have not had the benefit of testing these, so we cannot comment on them.

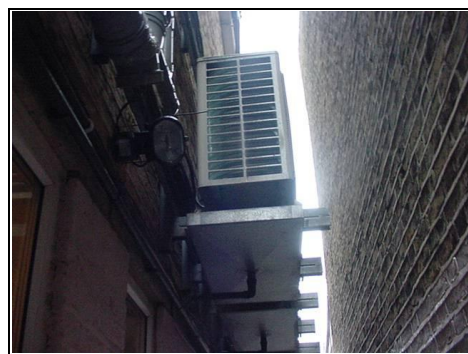

Finally, it should be noted that the supply pipe from the Water Company stopcock to the internal stop tap is the responsibility of the property owner.

We cannot comment on the condition of the water service pipe to the building. It should be appreciated that leaks can occur for some time before signs are apparent on the surface.

BATHROOM

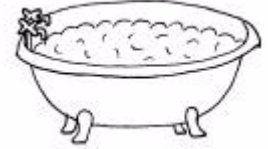

In this section we consider the overall condition of the sanitary fittings such as the bathroom, the kitchen, the utility room and the cloakroom.

Downstairs W.C.

The downstairs W.C. comprises a toilet and wash hand basin. It also has a washer unit which is leaking.

ACTION REQUIRED: In our experience washer units always leak, luckily there is a drain directly below it.



Washer unit in downstairs w.c. is leaking

En-suite bathroom to front left hand bedroom

This comprises a three piece bathroom suite, consisting of a bath, shower, wash hand basin and WC, which looks in average condition. The shower mastic needs checking.

Please see our comments in the Executive Summary.



En-suite bathroom to front left hand bedroom

———— Marketing by: ————

www.1stAssociated.co.uk

0800 298 5424

En-suite shower room to front right hand bedroom

This comprises a three piece bathroom suite, consisting of a shower, wash hand basin and WC, which looks in average condition. We would recommend you check the seals around the shower.



En-suite shower room to front right hand bedroom

Bathroom to top floor

This comprises a three piece bathroom suite, consisting of a shower, wash hand basin and WC, which looks in average condition. Again, we would recommend you check the seals around the shower.

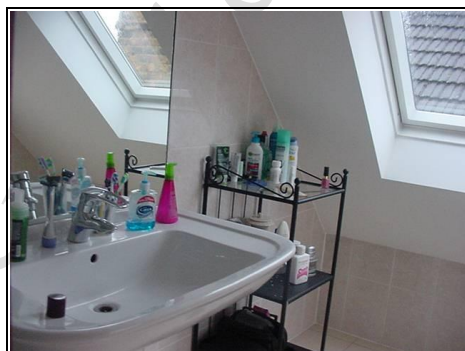

Bathroom to top floor

Rather unusually there isn't a family bathroom for the use of the rear bedroom to the left hand side or the room on the right hand side. The bathrooms would have to be accessed through the other rooms.

Finally, although we may have already mentioned it above we would reiterate that it is important to ensure that seals are properly made and maintained at the junctions between wall surfaces and baths and showers etc. We normally recommend that it is one of the first jobs that you carry out as part of your DIY on the property, as water getting behind sanitary fittings can lead to unseen deterioration that can be costly, inconvenient and difficult to repair.

Marketing by: _____

www.1stAssociated.co.uk

0800 298 5424

MAIN DRAINS



The sanitary system, as we know it now, came into being some 100 years ago during the Victorian era and works so successfully today it is often taken for granted. It is only in recent years that re-investment has taken place to upgrade the original drainage systems.

It is assumed that the foul drains from the property discharge into a public sewer; this should be confirmed by your Legal Advisor prior to exchange of contracts, who should also provide information in respect of any common or shared drains including liability for the maintenance and upkeep of the same.

The cold taps have been run for approximately quarter of an hour in the bathroom and kitchen. No build up or back up was noted.

Inspection Chambers / Manholes

For your information, inspection chambers / manholes are required to be provided in the current Building Regulations at each change of direction or where drainage runs join the main run.

We have identified four inspection chambers / manholes.

Manholes Defined

Access areas which usually fit a man (or woman) into them and are put in where the drains change direction.

Inspection Chamber / Manhole One – located to the rear right hand side

We duly lifted the cover and found it to be free flowing at the time of our inspection.

From what we could see it is plastic.



Manhole one

Marketing by: _____

www.1stAssociated.co.uk

0800 298 5424

Inspection Chamber / Manhole Two – located to the middle right hand side

We duly lifted the cover and found it to be free flowing at the time of our inspection.

From what we could see it is concrete built.



Manhole two

Inspection Chamber / Manhole Three –located in the middle

We were unable to lift this manhole. It is known as a modern inspection chamber.



Manhole three

Inspection Chamber / Manhole Four – located to the front right hand corner

We were unable to lift this manhole.

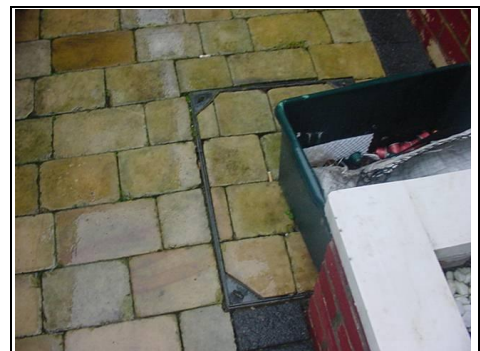

Manhole four

We have only undertaken a visual inspection of the property's foul drains by lifting covers and running water from the taps within the house.

Finally, it must be emphasised that the condition of the property's foul drains can only be ascertained by the carrying out of a test; such a test has not been undertaken. Should there be leaks in the vicinity of the building then problems could occur, particularly with respect to the stability of the building's foundations. Drainage repairs are inevitably costly and may result in damage being caused to those areas of the property beneath, or adjacent to, which the drains have been run.

Rainwater/Surface Water Drainage

Whilst very innocent looking rainwater downpipes can cause lots of problems. If they discharge directly onto the ground they can affect the foundations and even if they are taken away to soak-aways they can attract nearby tree roots or again affect foundations.

Some rainwater drains are taken into the main drainage system, which is now illegal (as we simply do not have the capacity to cope with it), and can cause blockages to the main drains! Here we have done our best from a visual inspection to advise of any particular problems.

We have been unable to determine the ultimate means of rain/surface water disposal. In this age of property it is likely to be into shared drains. These can be a problem during heavy rainfall and peak periods, such as the 9 o'clock rush to work.

Finally, rain/surface water drains have not been tested and their condition or effectiveness is not known. Similarly, the adequacy of soak-aways has not been established although you are advised that they tend to silt up and become less effective with time.

Please also see our comments within the Gutters and Downpipes section.

OUTSIDE AREAS

PARKING



There is a car parking area to the front of the property.



EXTERNAL AREAS

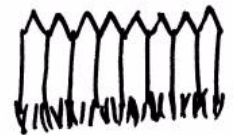

Front Garden

The front garden has been given over to parking (see above). There is a brickwork boundary wall which is starting to deteriorate.



Deterioration to front left hand boundary wall

Marketing by: _____
www.1stAssociated.co.uk
0800 298 5424

Rear Garden

The rear garden has a patio area and a grassed area. Please note our comments on the tree in the Trees Section, which could affect your insurance and could be affecting the rear of the property.



Boundaries: The left hand boundary (all directions given as you face the property) is usually the responsibility of the subject property.

Finally, whilst we note the boundaries, these may not be the legal boundaries. Your Legal Advisor should make further enquiries on this point and advise you of your potential liability with regard to any shared structures, boundary walls and fences.

Neighbours

Left Hand Neighbours

The left hand neighbours were not in at the time of our inspection.

Right Hand Neighbours

We knocked, but no-one answered at the time of our inspection.

POINTS FOR YOUR LEGAL ADVISOR

If you wish to proceed with your purchase of the property a copy of this report should be forwarded to your Legal Advisor and the following points should be checked by him/her:

- a) Responsibility for boundaries.
- b) Rights for you to enter onto the adjacent property to maintain any structure situated near or on the boundary and any similar rights your neighbour may have to enter onto your property.
- c) Obtain any certificates, guarantees or approvals in relation to:
 - i) Timber treatments, wet or dry rot infestations.
 - ii) Rising damp treatments.
 - iii) Cavity wall insulation and cavity wall tie repairs.
 - iv) Double glazing or replacement windows.
 - v) Roof and similar renewals.
 - vi) Central heating installation.
 - vii) Planning and Building Regulation Approvals.
 - viii) Removal of any walls in part or whole.
 - ix) Removal of any chimneys in part or whole.
 - x) Any other matters pertinent to the property.
- d) Confirm that there are no defects in the legal Title in respect of the property and all rights associated therewith, e.g., access.
- e) Rights of Way e.g., access, easements and wayleaves.
- f) Liabilities in connection with shared services.
- g) Adjoining roads and services.
- h) Road Schemes/Road Widening.
- i) General development proposals in the locality.

- j) Conservation Area, Listed Building, Tree Preservation Orders or any other Designated Planning Area.
- k) Confirm from enquiries that no underground tunnels, wells, sewers, gases, mining, minerals, site reclamation/contamination etc., exist, have existed or are likely to exist beneath the curtilage of the site upon which the property stands and which could affect the quiet enjoyment, safety or stability of the property, outbuildings or surrounding areas.
- l) Our Report assumes that the site has not been put to contaminative use and no investigations have been made in this respect.
- m) Any outstanding Party Wall Notice or the knowledge that any are about to be served.
- n) Most Legal advisors will recommend an Envirosearch or a similar product is used by you to establish whether the area falls within a flood plain, old landfill site, radon area etc. If your Legal Advisor is not aware of Envirosearch or similar please ensure that they contact us and we will advise them of it. Any general findings should be brought to their logical conclusion by using appropriate specialist advisers.

However, with regard to Envirosearch or similar general reports please see our article link on the www.1stAssociated.co.uk Home Page.

- o) Any other matters brought to your attention within this report.

LOCAL AUTHORITY ENQUIRIES

Your Legal Advisor should carry out Local Authority searches to ascertain whether the property is a Listed Building and whether it is situated in a Conservation Area. They should also find out any information available with regard to Planning Applications and Building Control. We have not made any formal or informal Local Authority enquiries.

Finally, your Legal Advisor should carry out any additional enquiries they feel necessary and if they find anything unusual or onerous then we ask that they contact us immediately for our further comments.

It is our policy not to offer a conclusion to ensure that the Building Survey is read in full and the comments are taken in context.

If you would like any further advice on any of the issues discussed (or indeed any that have not been discussed!) then please do not hesitate to contact us on **0800 298 5424**.

Copyright: 1stAssociated.co.uk

———— Marketing by: ————
www.1stAssociated.co.uk
0800 298 5424

REFERENCES

The repair and maintenance of houses
Published by Estates Gazette Limited

Life expectancies of building components
*Published by Royal Institution of Chartered Surveyors and
Building Research Establishment*

Surveying buildings
*By Malcolm Hollis published by Royal Institution of
Chartered Surveyors Books.*

House Builders Bible
By Mark Brinkley, Published by Burlington Press.

Copyright: 1stAssociated.co.uk

———— Marketing by: ————
www.1stAssociated.co.uk
0800 298 5424

APPENDICES

1. The electrical regulations – Part P of the Building Regulations
2. Information on the Property Market
3. French Drain Article

———— Marketing by: ————
www.1stAssociated.co.uk
0800 298 5424

86

THE ELECTRICAL REGULATIONS – PART P OF THE BUILDING REGULATIONS

Here is our quick guide to the Regulations, but please take further advice from a qualified and experienced electrician.

From 1st January 2005, people carrying out electrical work in homes and gardens in England and Wales must follow new rules in the building regulations. All significant electrical work carried out in the home will have to be undertaken by a registered installer or be approved and certified by the local authority's building control department. Failure to do so will be a legal offence and could result in a fine. Non-certified work could also put your household insurance policy at risk.

If you can't provide evidence that any electrical installation work complies with the new regulations, you could have problems when it comes to selling the property.

There will be two ways in which to prove compliance:

1. A certificate showing the work has been done by a Government-approved electrical installer - British Gas or NICEIC Electrical Contractor.
2. A certificate from the local authority saying that the installation has approval under the building regulations.

Homeowners will still be able to do some minor electrical jobs themselves. To help you, we've put together this brief list of dos and don'ts.

Work You Cannot do Yourself

- Complete new or rewiring jobs.
- Fuse box changes.
- Adding lighting points to an existing circuit in a 'special location' like the kitchen, bathroom or garden.
- Installing electrical earth connections to pipework and metalwork.
- Adding a new circuit.

INFORMATION ON THE PROPERTY MARKET

We used to include within our reports articles on the property market that we thought would be of interest and informative to you, however we were concerned that in some cases these did not offer the latest information. We have therefore decided to recommend various websites to you, however it is important to realise the vested interest the parties may have and the limits to the information.

www.landreg.org.uk

This records the ownership of interests in registered land in England and Wales and issues a residential property price report quarterly, which is free of charge. The Land Registry is a Government body and records all transactions as far as we are aware, although critics of it would argue that the information is often many months out of date.

www.rics.org.uk

The Royal Institution of Chartered Surveyors offer quarterly reports via their members. Although this has been criticised as being subjective and also limited, historically their predictions have been found to be reasonably accurate.

www.halifax.co.uk and www.nationwide.co.uk

Surveys have been carried out by these two companies, one now a bank and the other a building society for many years. Information from these surveys is often carried in the national press. It should be remembered that the surveys only relate to mortgaged properties, of which it is generally considered represents only 75% of the market. It should also be remembered that the national coverage of the two companies differs and that they may be offering various incentives on different mortgages, which may taint the quality of information offered. That said they do try to adjust for this, the success or otherwise of this is hard to establish.

www.hometrack.co.uk

This gives information with regard to house sale and purchase prices.

www.motleyfool.co.uk

We also like the Motley Fool website which is a general financial site and although it is selling financial services and other services they do tend to give a very readable view of the housing market.

www.rightmove.co.uk

This is probably the largest Internet search engine for estate agency sales and also has useful information with regard to prices of property (but it is not the same as having a chartered surveyor value it).

www.zoopla.co.uk

This is a very good website for seeing the prices of properties for sale in a certain postcode area.

Copyright: 1stAssociated.co.uk

———— Marketing by: ————
www.1stAssociated.co.uk
0800 298 5424

French Drain

Using a French drain to resolve a dampness problem

We are finding where we are asked to look at damp walls and damp floors or damp problems in general that commonly it is because the external ground level is higher than the internal ground level, or airbricks have been blocked, or simply paving slabs, decking or briquettes have been used to form a patio area. This then discharges any rainwater against the building. Quite often the solution is to add a French drain.

Whilst French drains are quite simple and are basically nothing more than trenches filled with gravel, although there is a bit more to them, as we will explain, they are almost a D.I.Y. job for most people and they are relatively easy to install and are low cost. However, you do need some care and attention, otherwise you can install what we have heard referred to, as the French pond.

What use is a French drain?

A French drain is a trench, the width of approximately six inches or 300 millimetres wide, or the width of your spade, and is approximately twice the depth, i.e. 12 inches or 300 millimetres. In most cases this will suffice, however, where there is a great deal of ground water you may wish to make the trench wider and deeper.

The French drain acts as an area where water soaks away quickly. We often recommend them close to building, but not next to the building, as this helps reduce the ground level and/or take any water that is directed at that area away. For example, where a patio has been put in place which aims any rainwater at part of the wall. As mentioned, whilst a French drain is a D.I.Y. job, it does need some understanding of how it works.

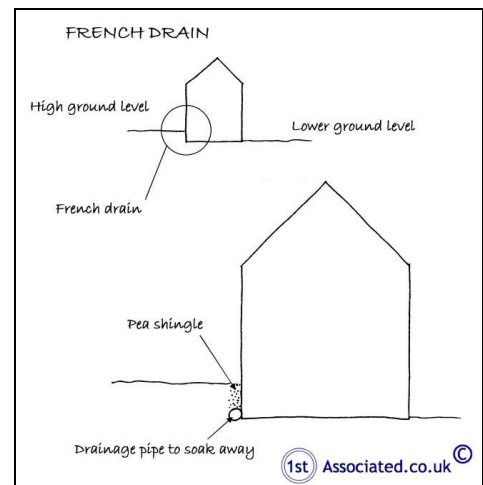

French drains must be on a slope

The piping that goes at the base of a French drain should be perforated or, as we did years ago for land drains, there should be gaps between each pipe. It should be set onto a bed of firm ground and the pipes should be on a fall to the drain. Whilst you should be able to ensure there is enough fall by sight, we also like the idea of rolling a marble from one end to the other.

You will then need to put the pipes down, fill the trench with half an inch, to an inch, of good sized gravel. You can leave it at that, or in addition you can cover with sand and then turf over. This is how a basic French drain is carried out.

The French drain system that we would recommend

This would be as described, although we would add to the base an inch or two of gravel on to which the perforated drainage pipe will rest. It will then wrap around that drainage pipe filter fabric. This is to stop the holes in the perforated pipe from blocking up. By the way, the drainage pipe should be four to six inches/100 millimetres to 250 millimetres. We would then fill with gravel. In addition to this, we would add a silt trap and this is added in the run of the pipe and is very similar to a road gully (not that's of much use if you don't understand how a road gully works). The silt trap is a rectangular box with a pipe opening at each end. The drained water passes onto this and any particles sink to the bottom of the box and then the water travels on to the other side of the box, enabling you to feed into a drain.

These are usually made of glass reinforced polyester and have been available in this form since the mid-1980's. They are normally reinforced with a steel frame for additional strength and re-bedded in concrete.

The French pond!

French drains will, over time, clog up, which is why we recommend using a filter fabric. However, even with this they will eventually clog up. Unfortunately, there is no dino-rod equivalent, as it is normally fine sand, organic matter or clay that has clogged up the French drain. So, it is a case of digging it up and cleaning the pipework (or it may be quicker to just replace it), adding a filter fabric and re-filling the gravel.

LIMITATIONS

Our limitations are as the agreed Terms and Conditions of Engagement.

CONDITIONS OF ENGAGEMENT

The report has been prepared in accordance with our Conditions of Engagement and should be regarded as a comment on the overall condition of the property and the quality of its structure and not as an inventory of every single defect. It relates to those parts of the property that were reasonably and safely accessible at the time of the inspection, but you should be aware that defects can subsequently develop particularly if you do not follow the recommendations.

ENGLISH LAW

We would remind you that this report should not be published or reproduced in any way without the surveyor's expressed permission and is governed by English Law and any dispute arising there from shall be adjudicated upon only by the English Courts.

SOLE USE

This report is for the sole use of the named Client and is confidential to the Client and his professional advisors. Any other persons rely on the Report at their own risk.

ONLY HUMAN!

Although we are pointing out the obvious, our Surveyors obviously can't see through walls, floors, heavy furniture, fixed kitchen units etc. they have therefore made their best assumptions in these areas.

As this is a one off inspection, we cannot guarantee that there are no other defects than those mentioned in the report and also that defects can subsequently develop.

———— Marketing by: ————
www.1stAssociated.co.uk
0800 298 5424

WEATHER

It was a cold day with intermittent light rain at the time of the inspection. The weather did not hamper the survey although it did make the decking on the roof very slippery.

In recent times our weather seems to be moving towards the extremities from its usual relatively mid range. Extremes of weather can affect the property.

NOT LOCAL

It should be noted that we are not local surveyors to this area and are carrying out the work without the benefits of local knowledge on such things as soil conditions, aeroplane flight paths, and common defects in materials used in the area etc.

OCCUPIED PROPERTY

The property was occupied at the time of our survey, which meant that there were various difficulties when carrying out the survey such as stored items within cupboards, the loft space and obviously day-to-day household goods throughout the property. We have, however, done our best to work around these.

INSPECTION LIMITED

Unfortunately in this instance our inspection has been very limited as we did not have full access to the roof. We were not able to open up the floors and unable to view them as they were covered with wood flooring/tiles. We didn't have the benefit of meeting you at the property to understand your exact property needs. The property was occupied by the owner's son who carried out our question and answer session and questionnaire as best as he could.

BUILDING INSURANCE

We do not advise with regard to building insurance. You need to make your own enquiries. Some areas may have a premium, some buildings may have a premium and some insurers may be unwilling to insure at all in certain areas. You need to make your own enquires prior to committing to purchase the property. Please be aware the fact a building is currently insured does not mean it can be re insured.

We would comment that non-insurability of a building we feel will affect value. It is therefore essential to make your own enquiries with regard to insurance before committing to purchase the property and incurring fees.

ACTION REQUIRED: You need to contact an insurance company today to make enquiries with regard to insurance on this property.

TERMS AND CONDITIONS

Our computer system sends two copies of our Terms and Conditions to the email address given to us when booking the survey; one has the terms attached and the other has links to the Terms and Conditions on our website (for a limited time). If you have not received these please phone your contact immediately.

———— Marketing by: ————

www.1stAssociated.co.uk

0800 298 5424